

HAD

EM

INNER

Temporary support

Flange

Rails

ACCESS

HAD

LAr Cal

AEJ

JM

FCAL

JNose

TAS

QUAD

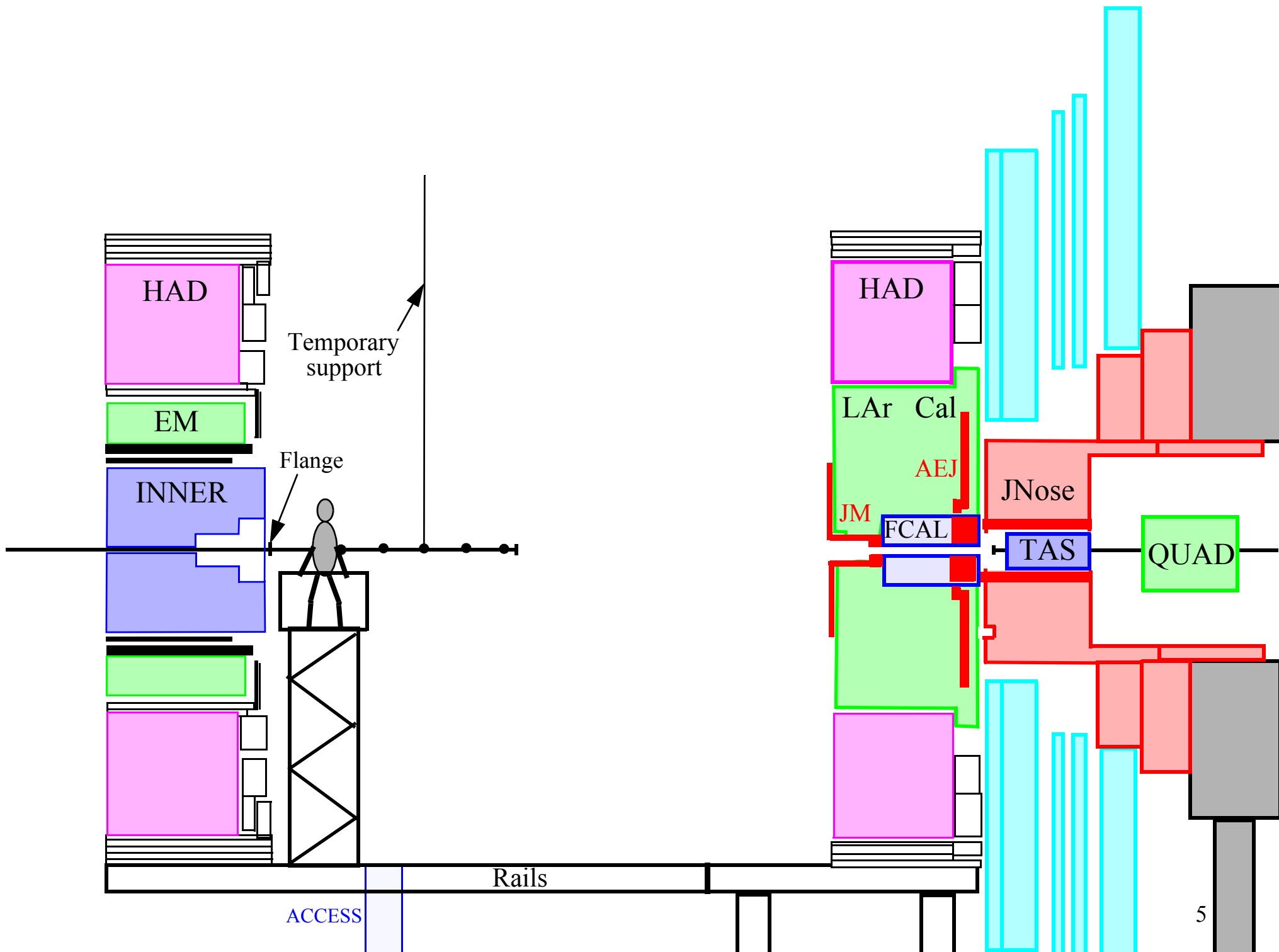

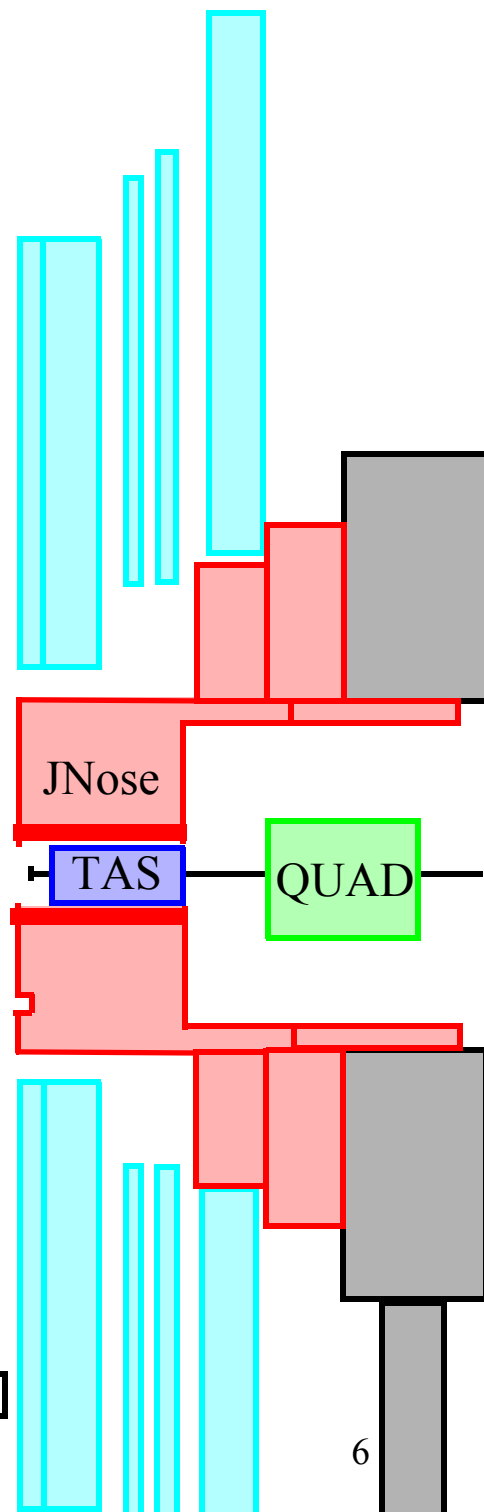
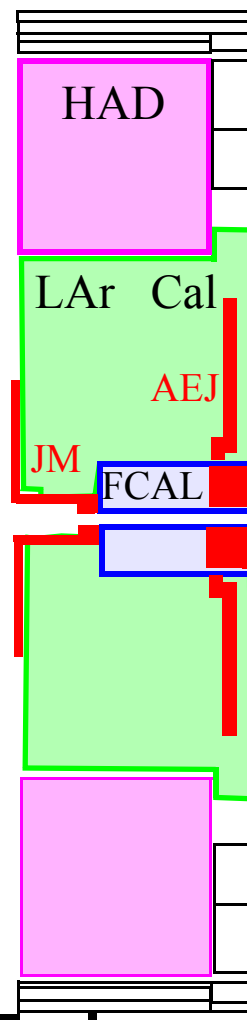
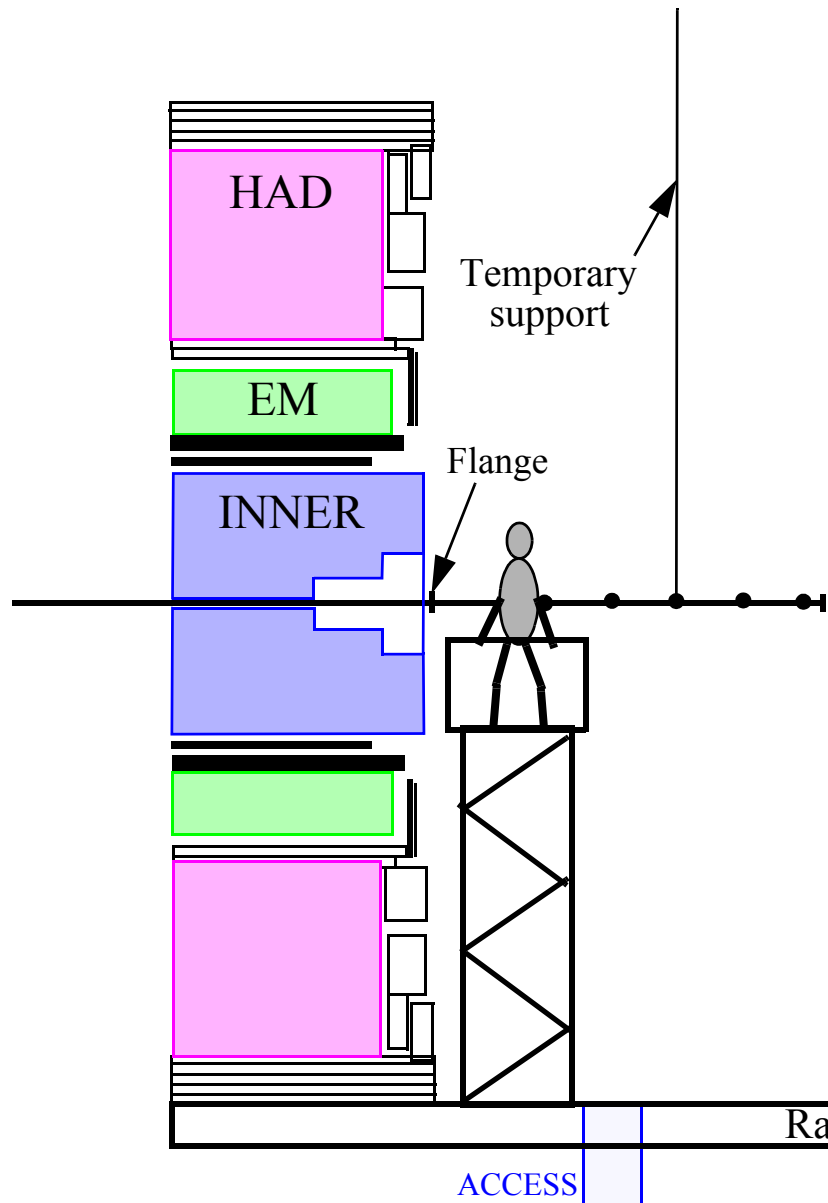

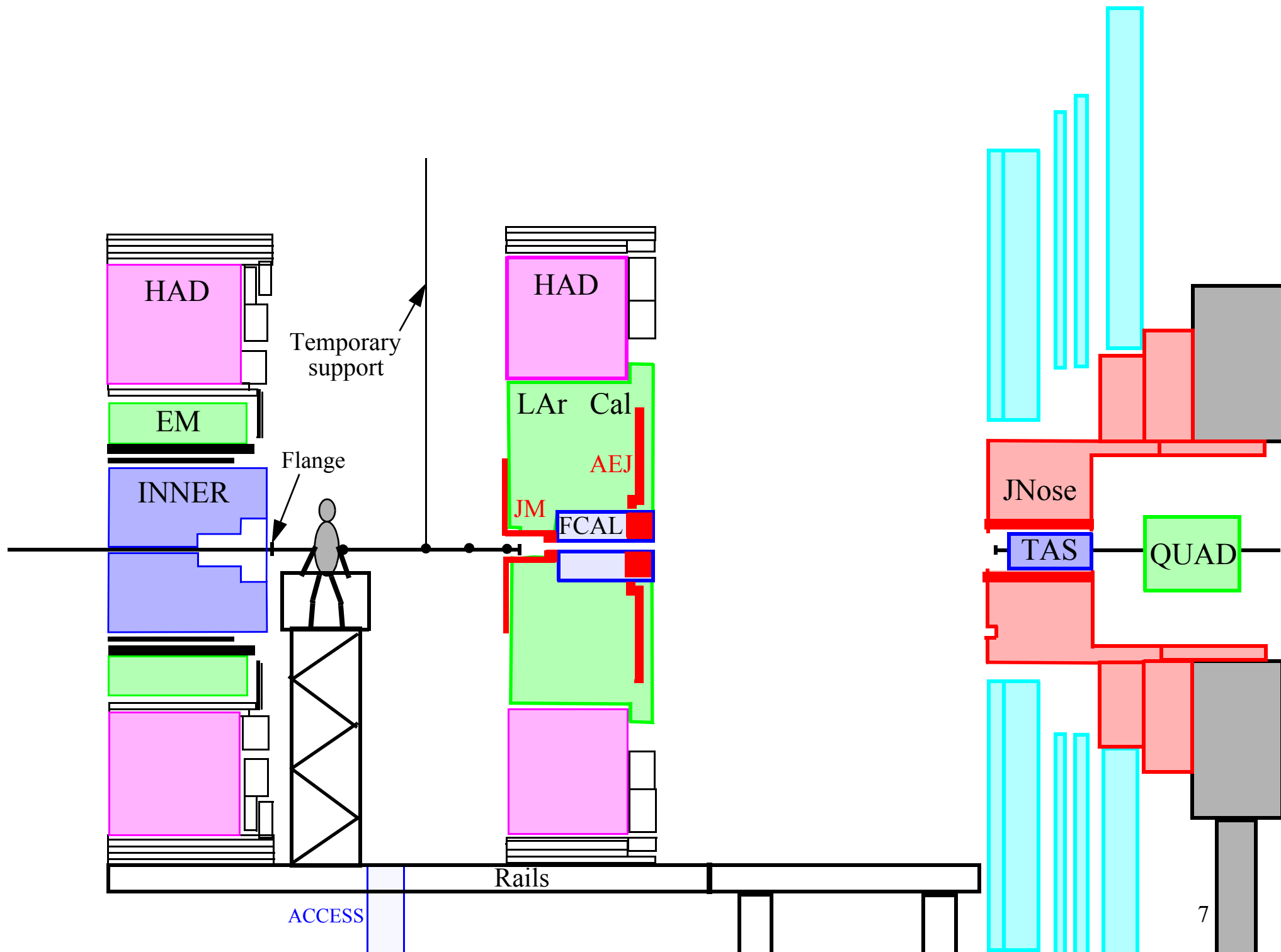

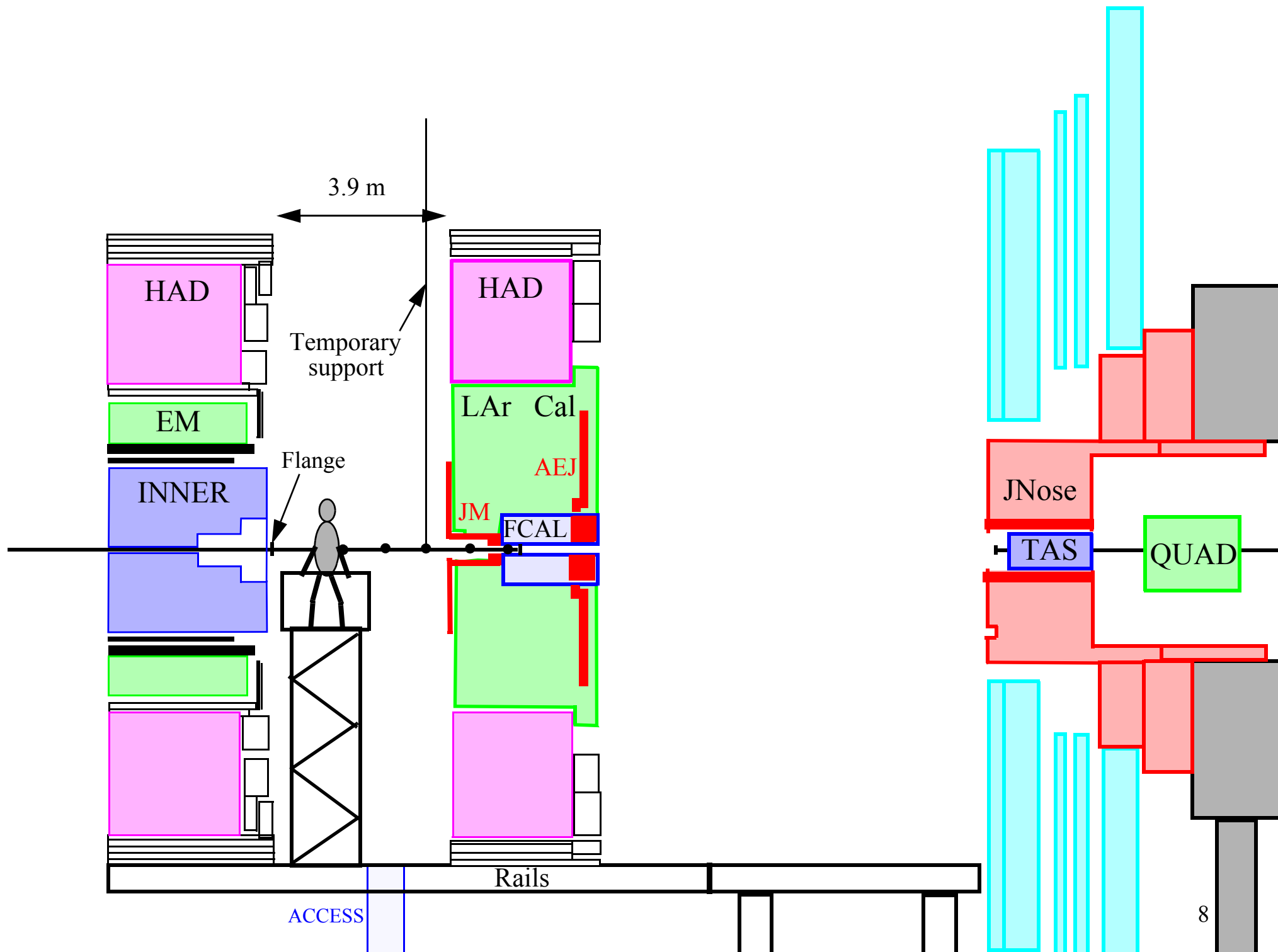

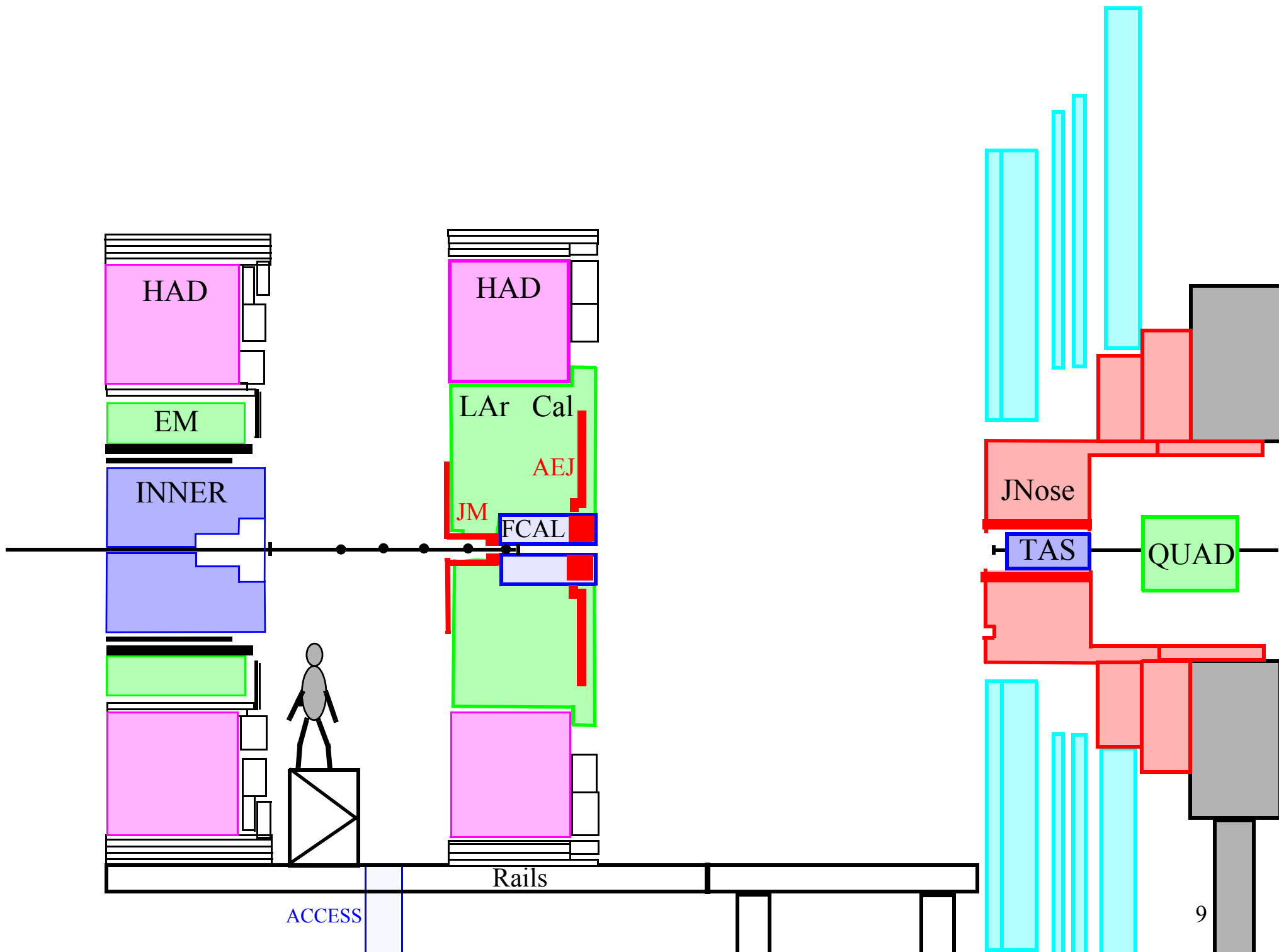

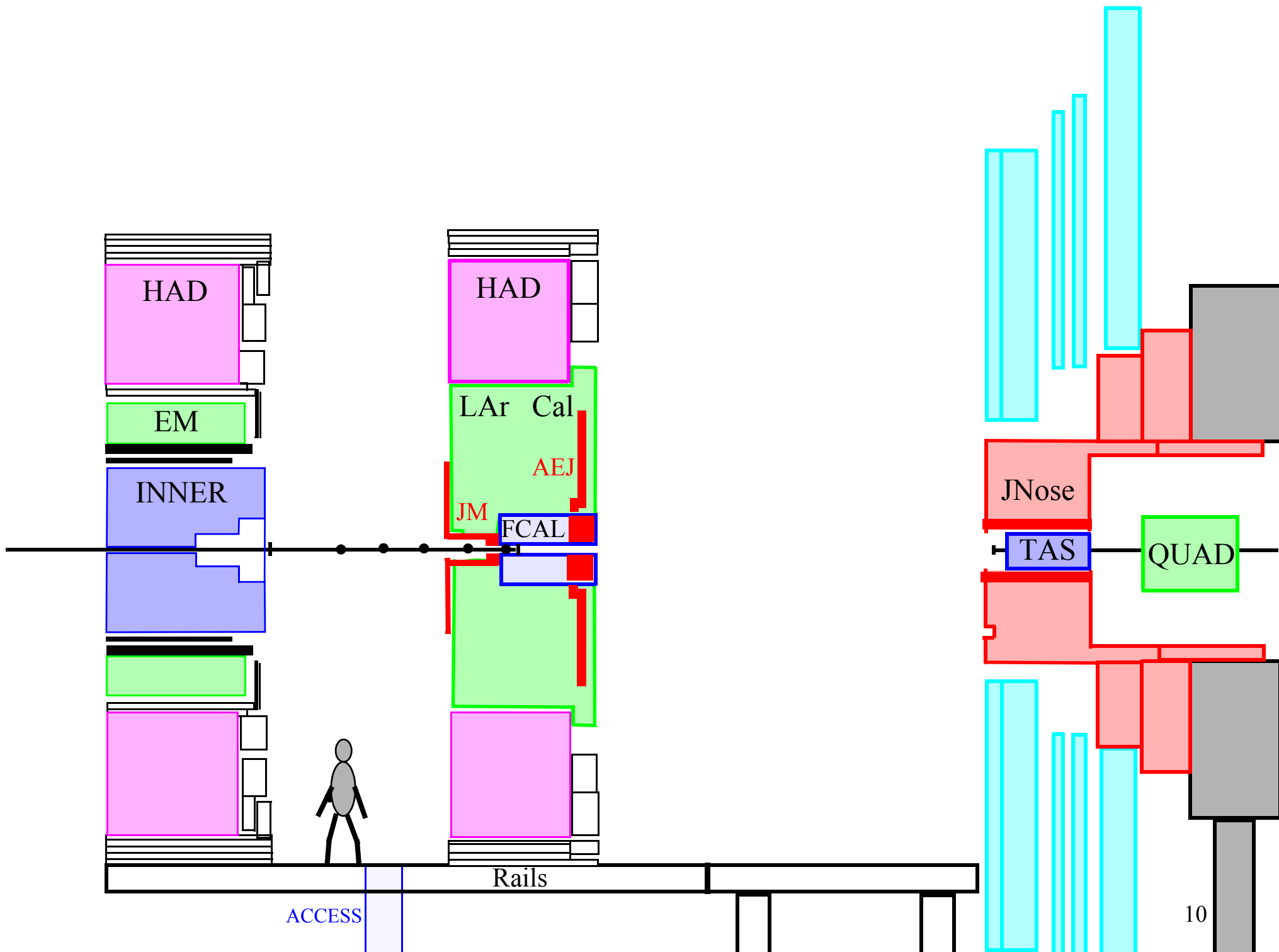

HAD

EM

INNER

HAD

LAr Cal

AEJ

JM

FCAL

JNose

TAS

QUAD

ACCESS

Rails

10

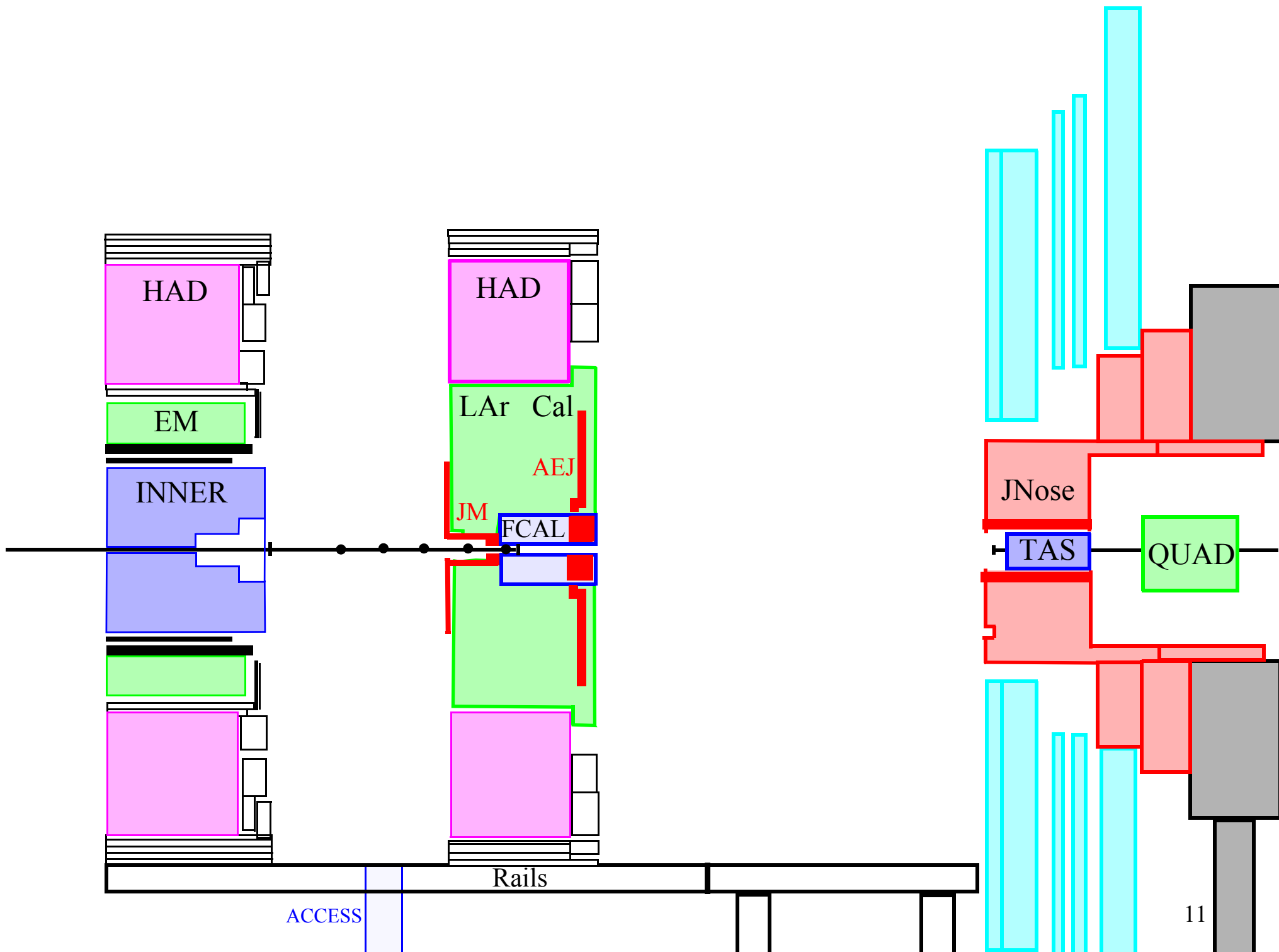

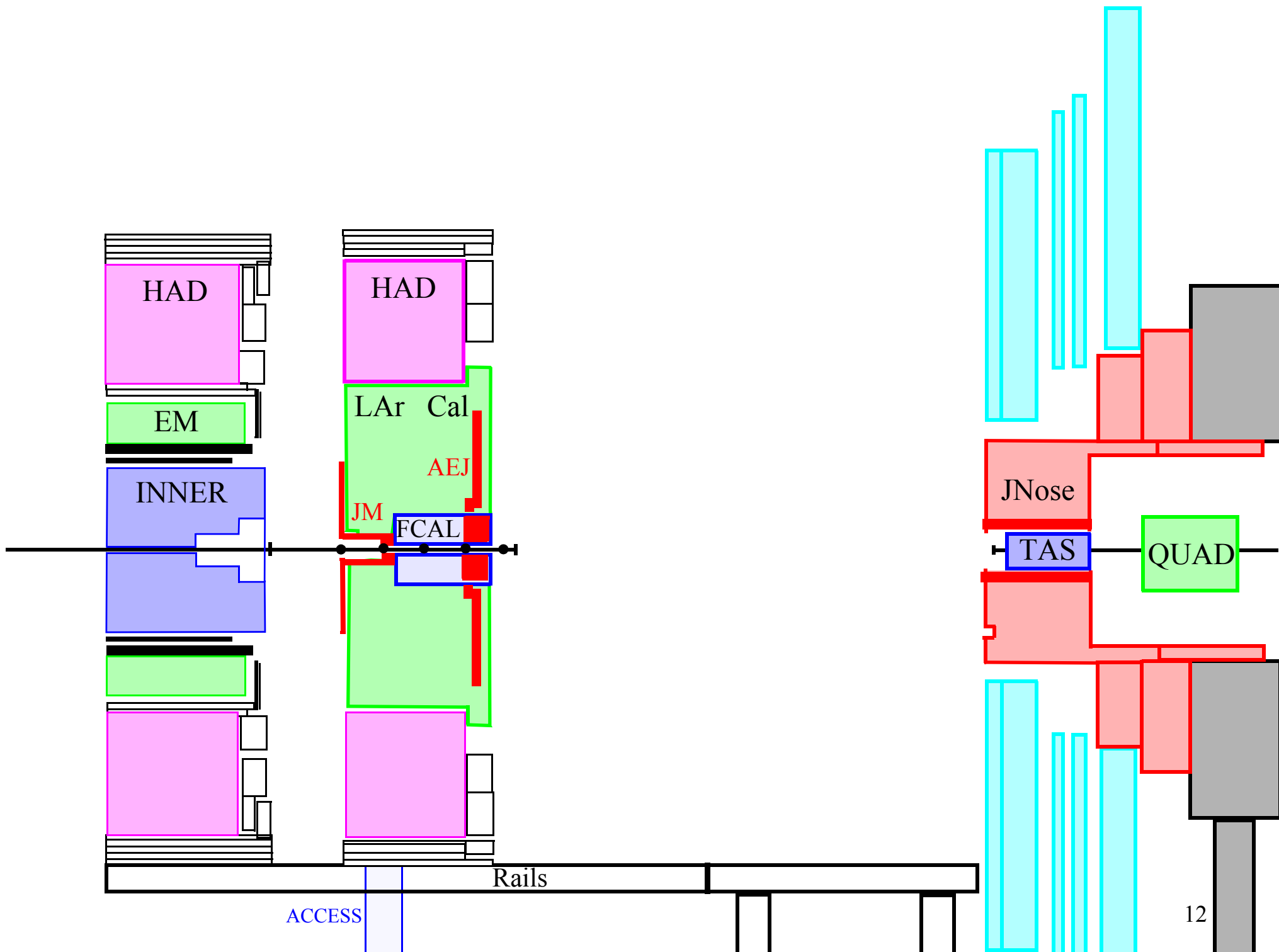

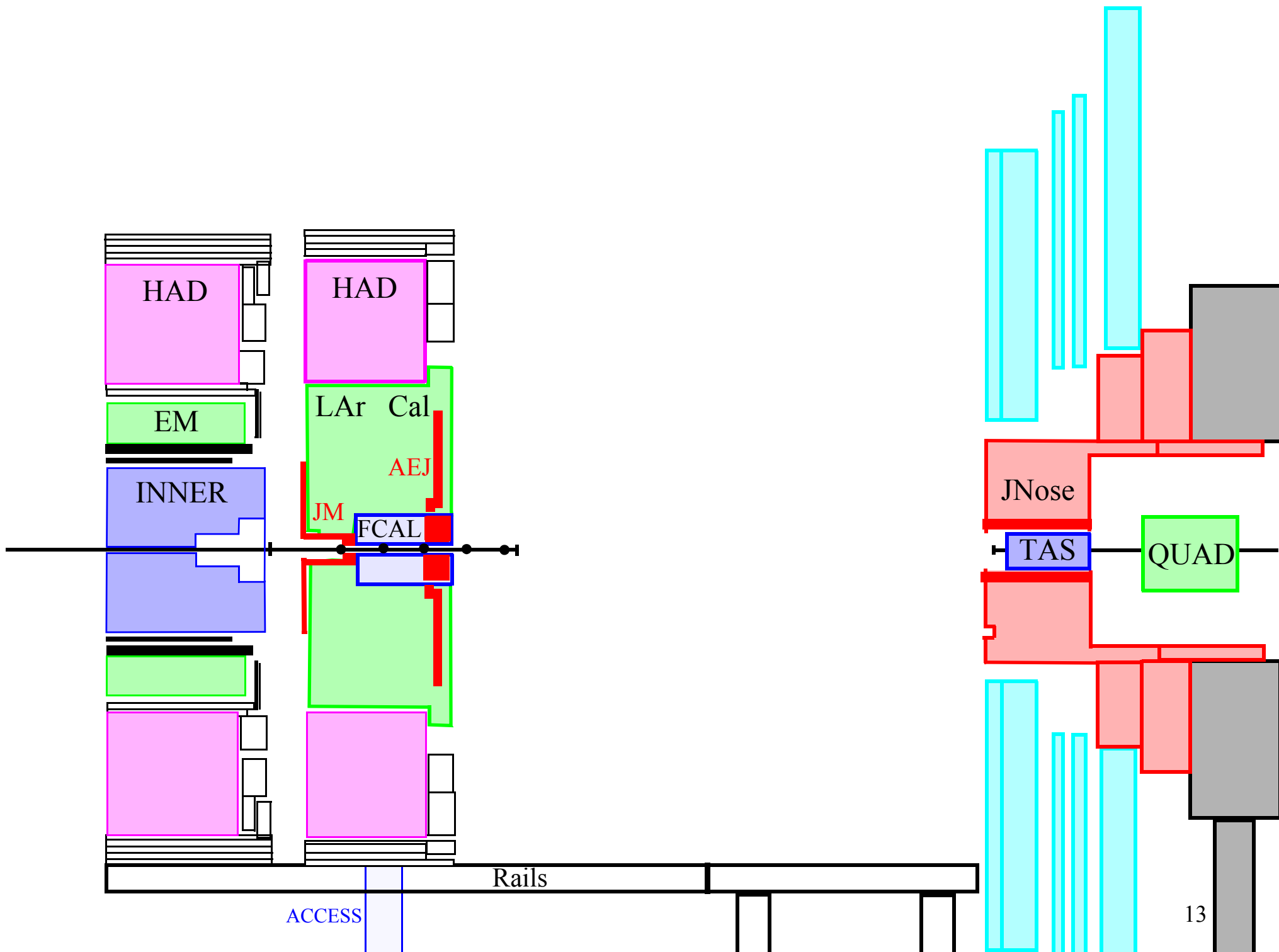

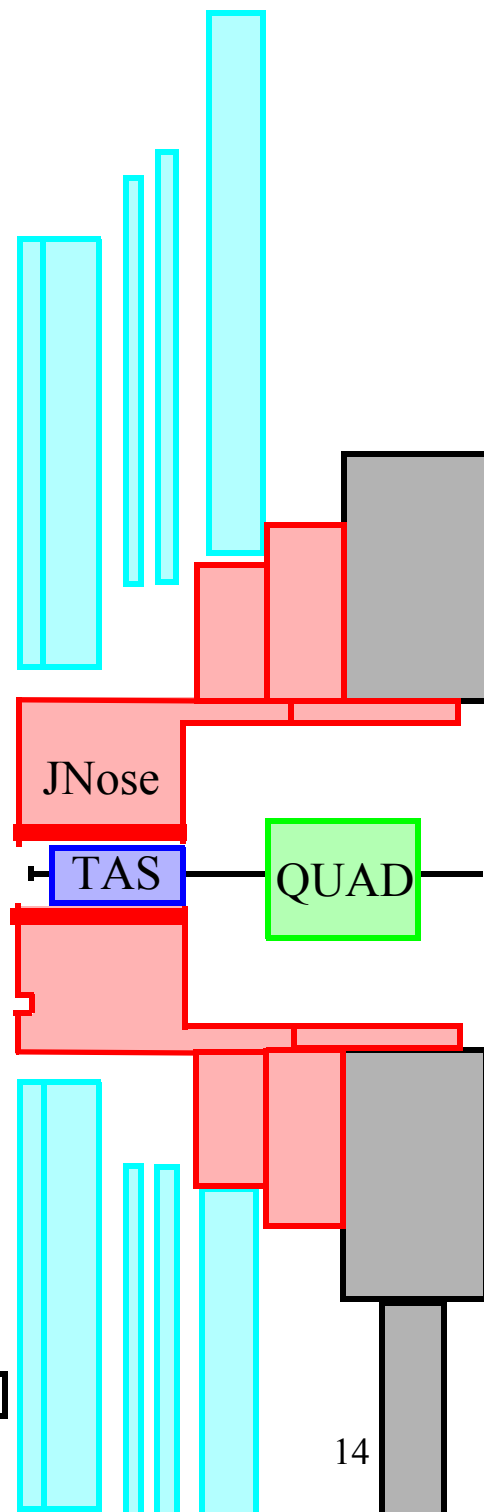
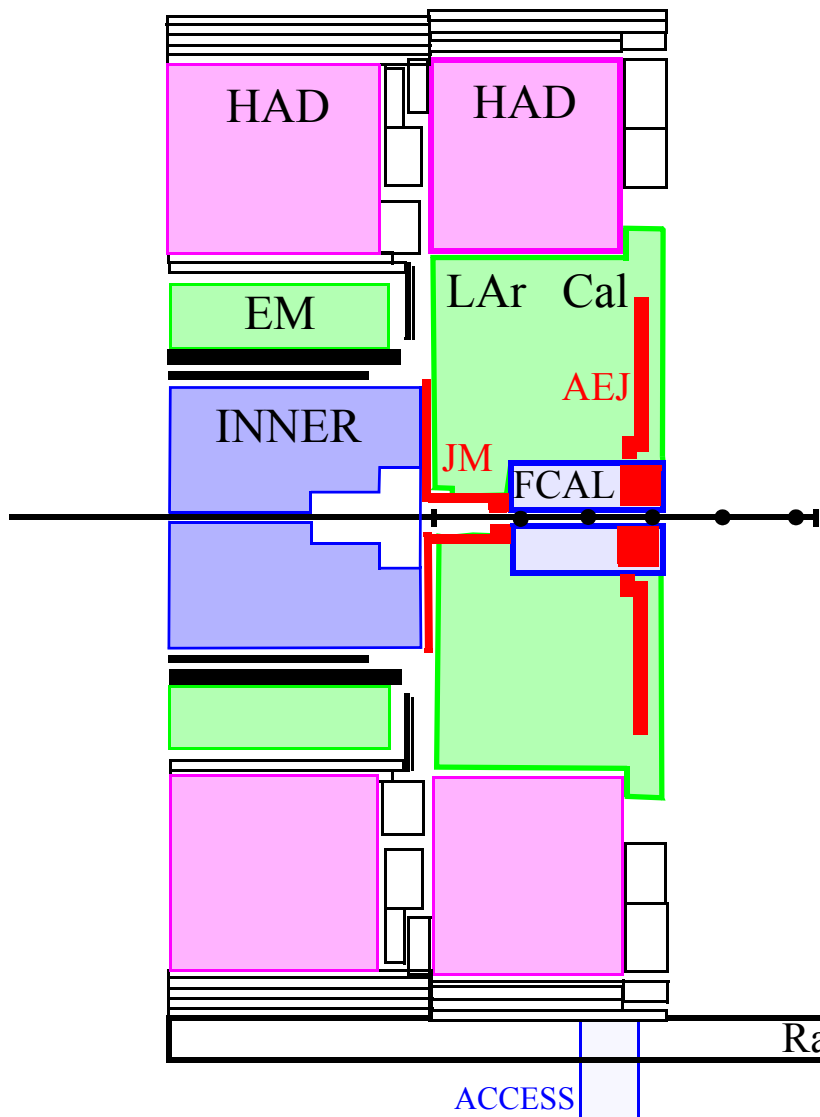

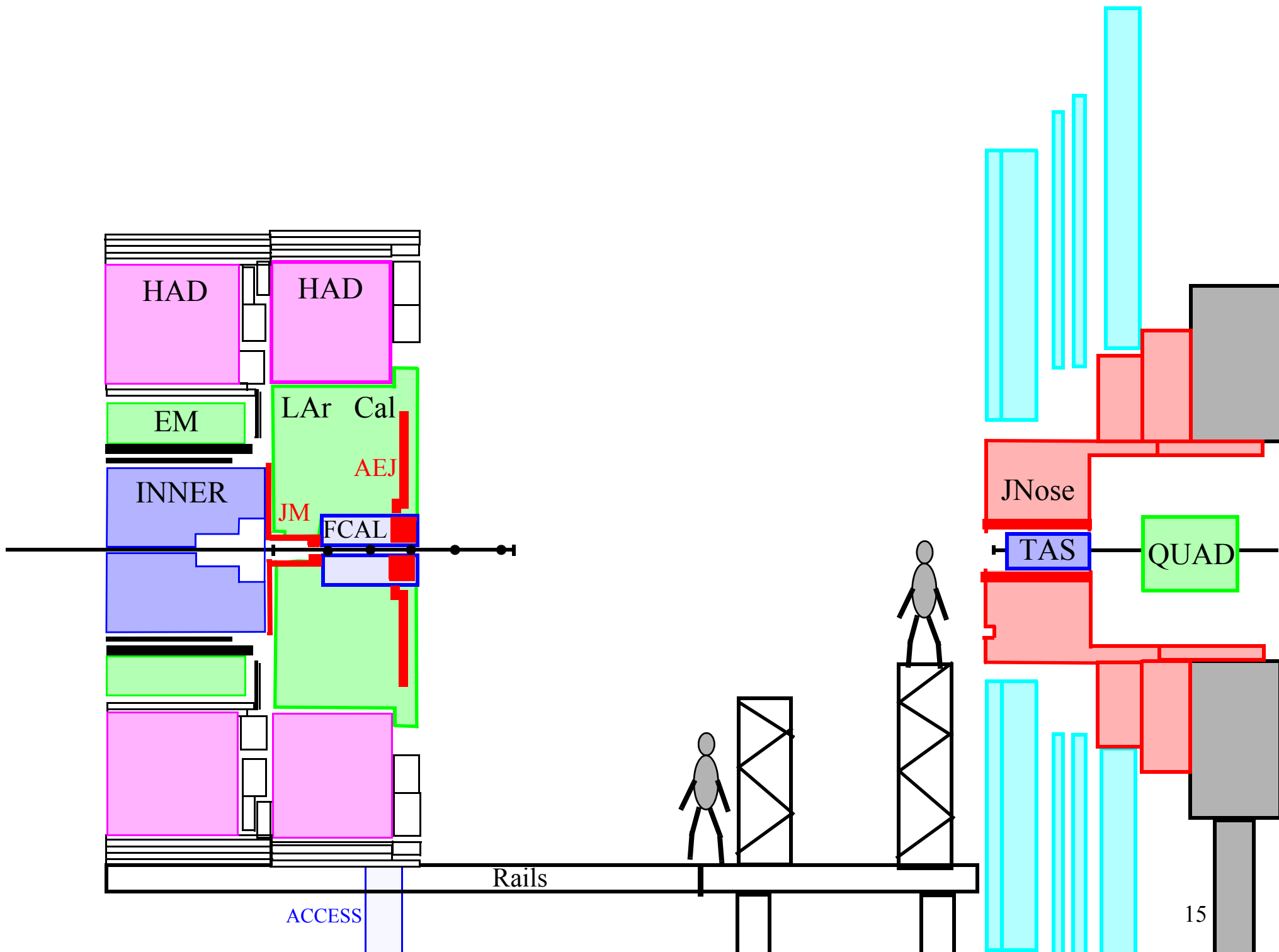

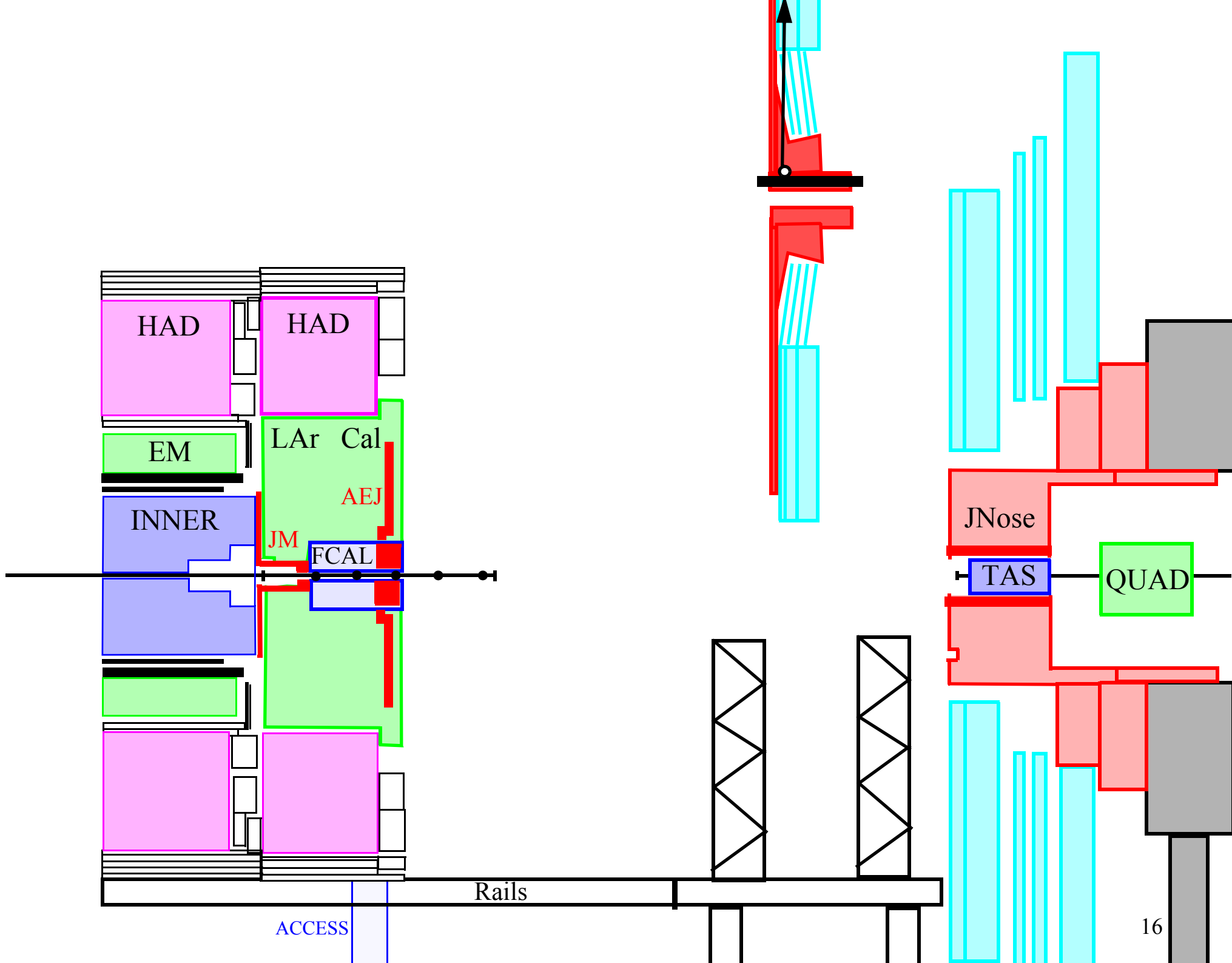

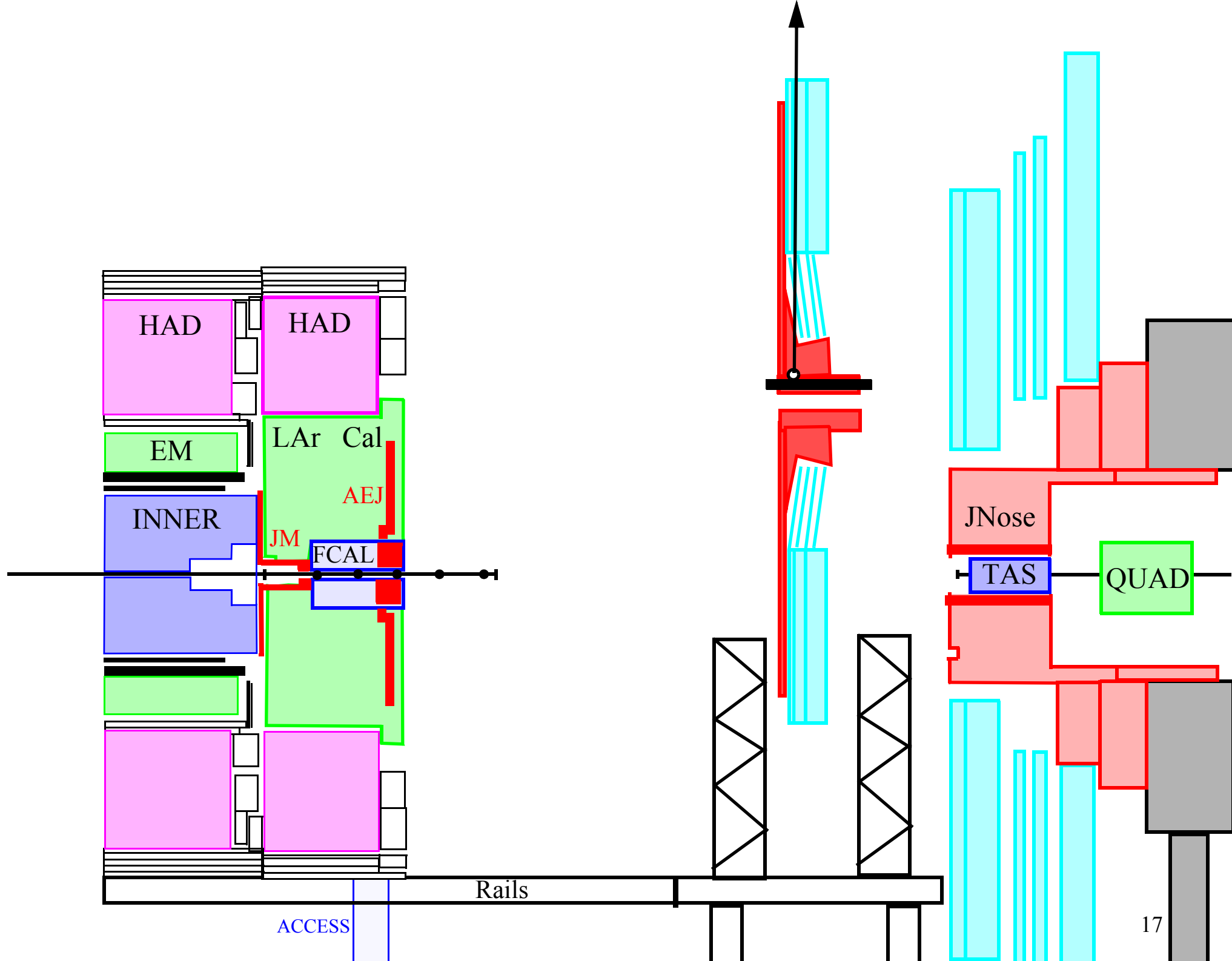

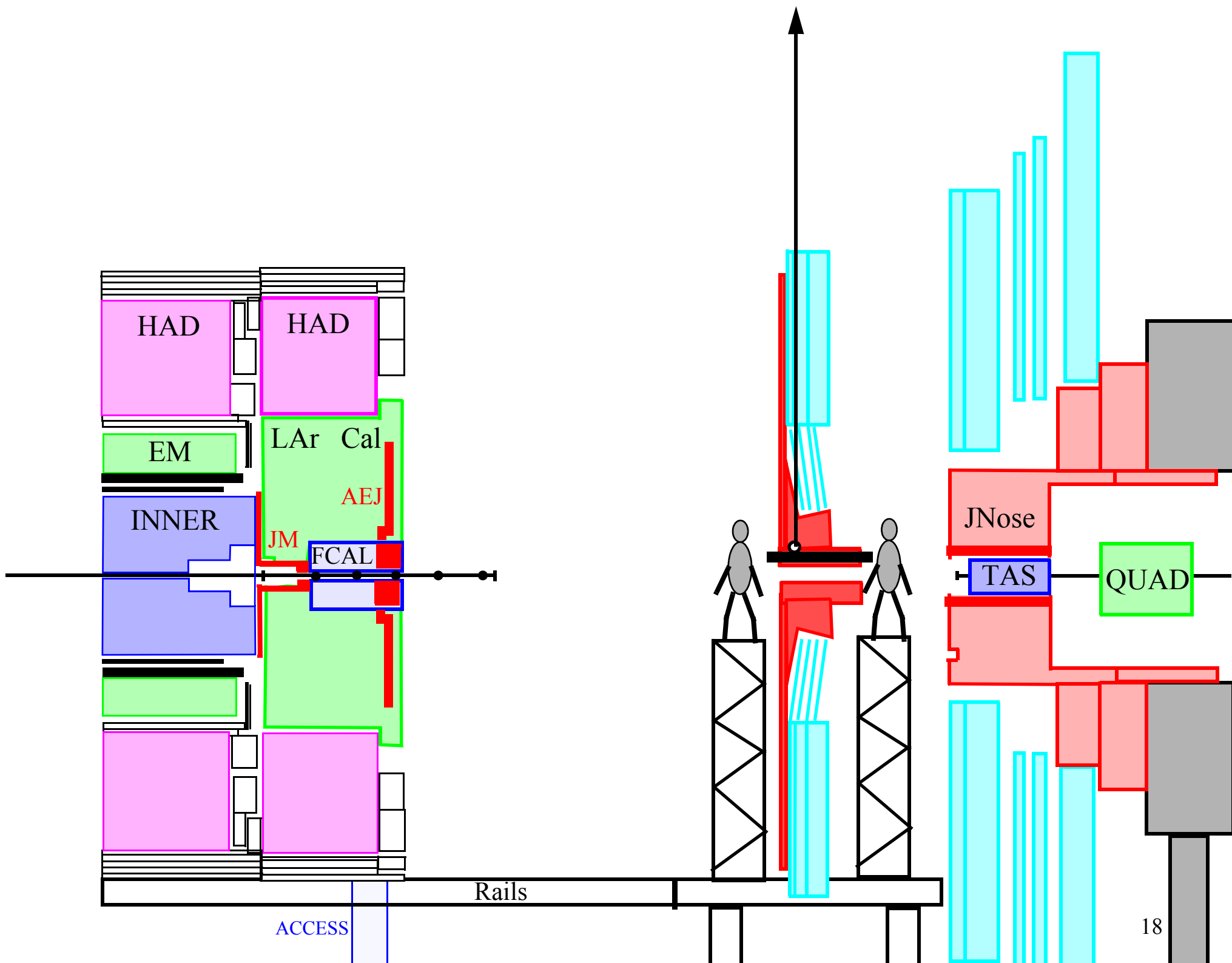

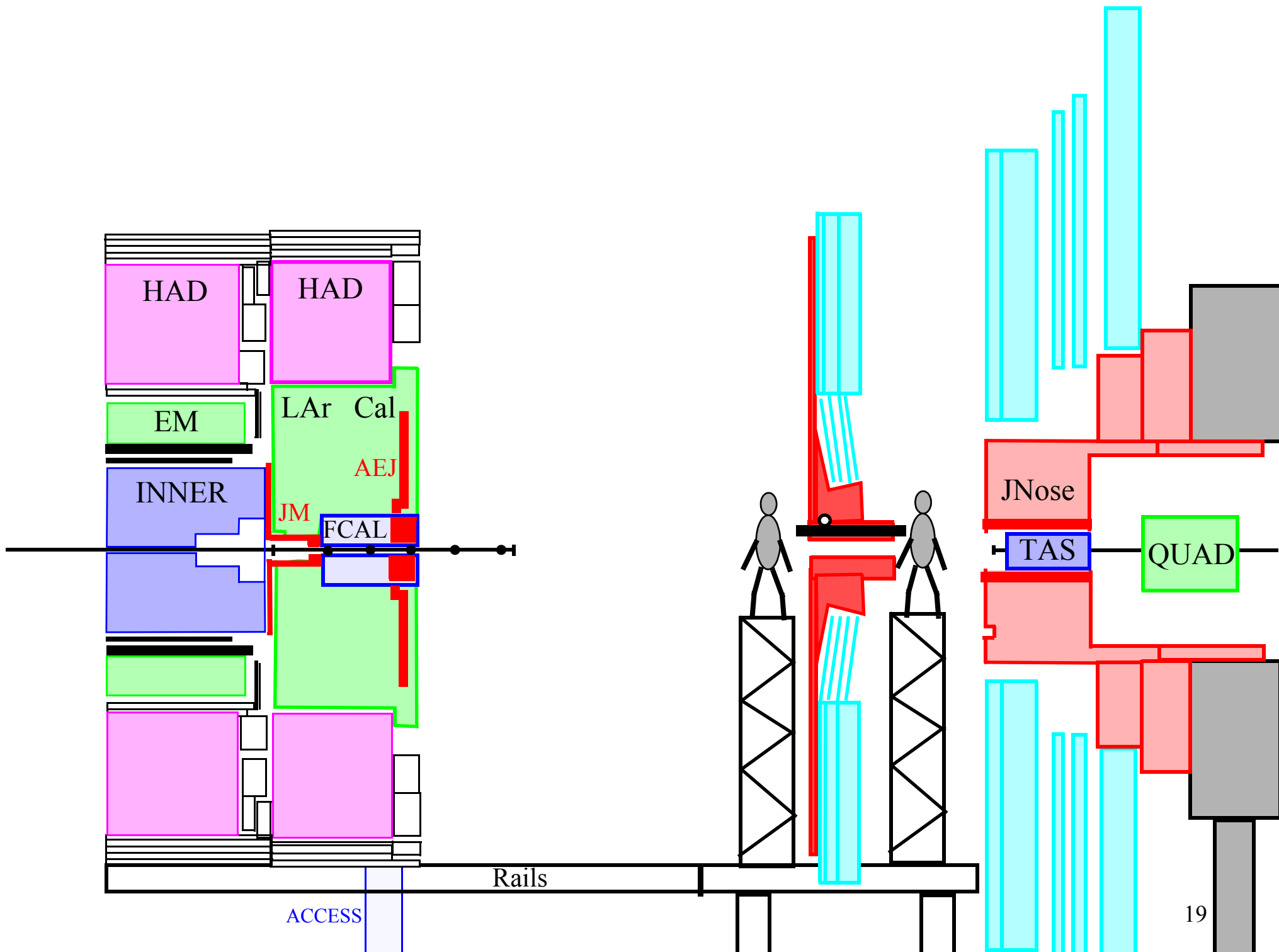

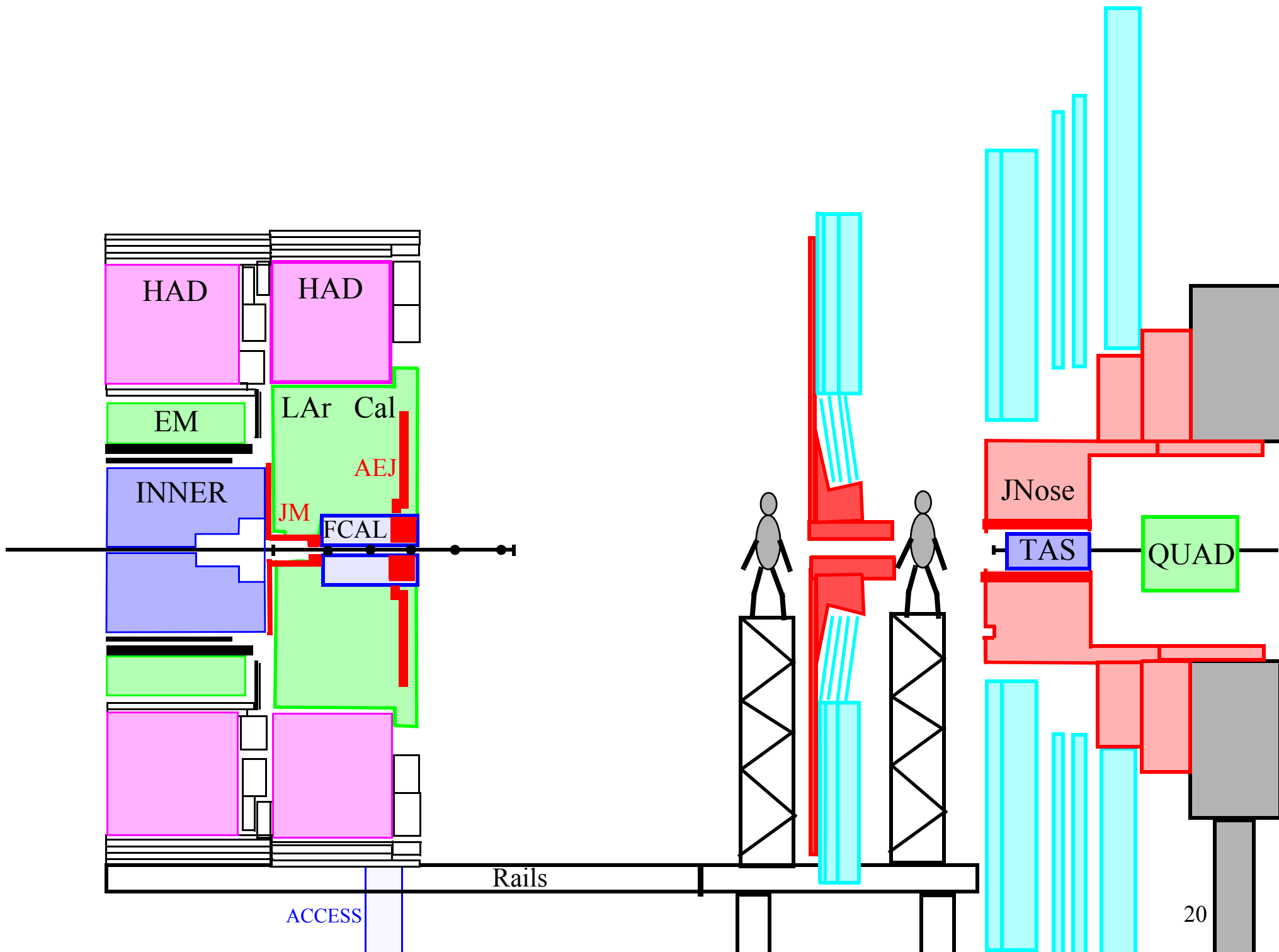

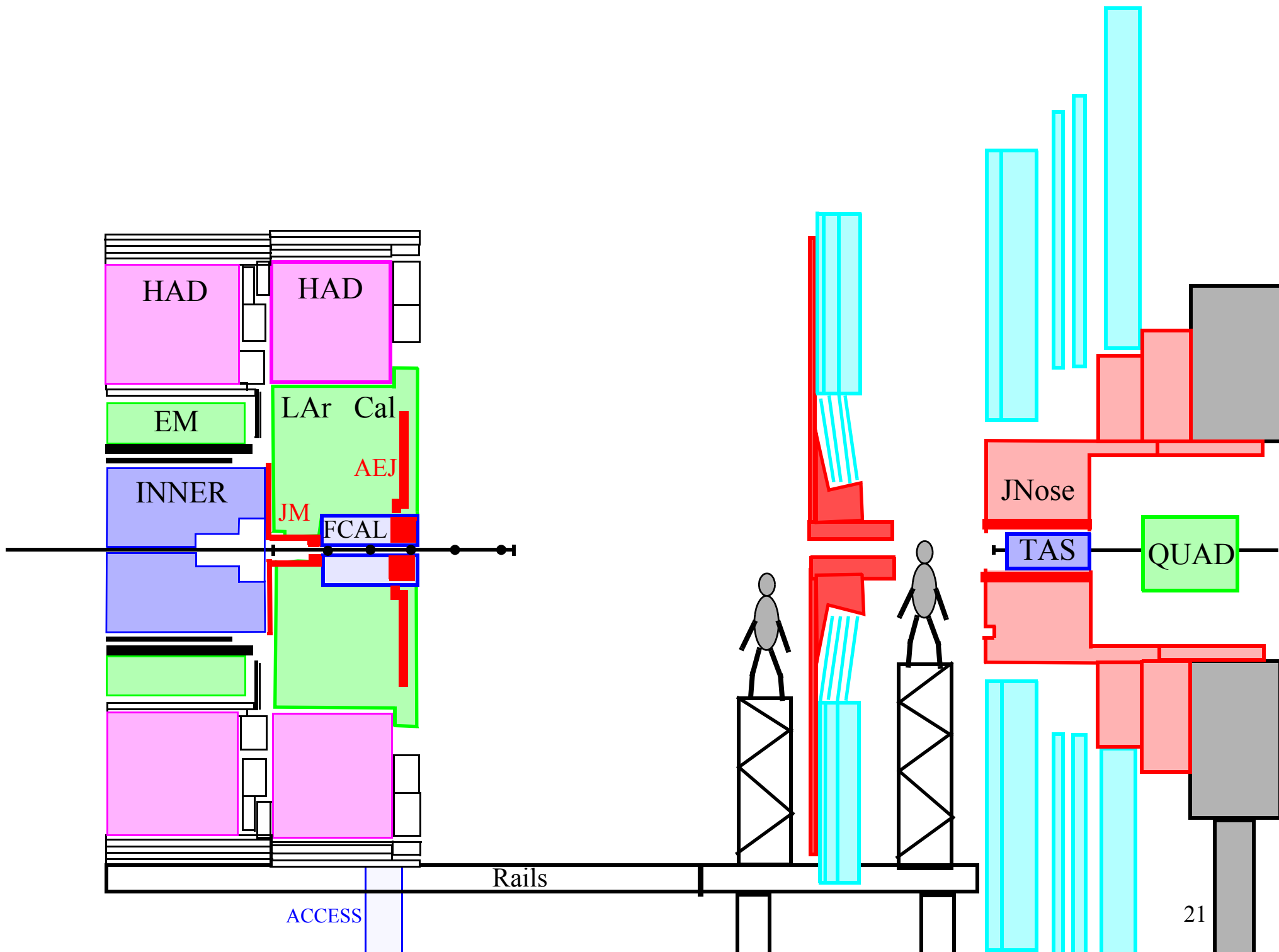

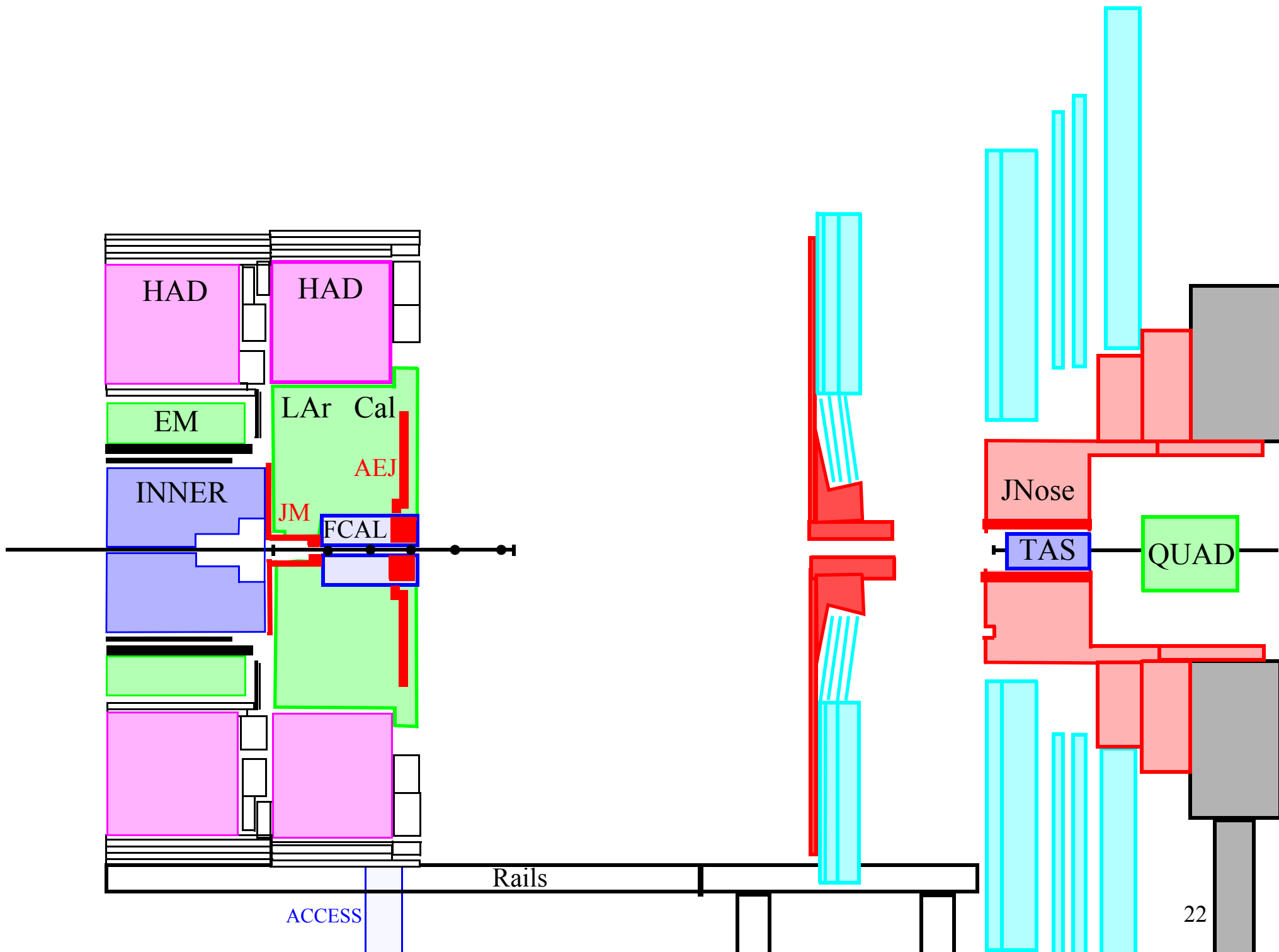

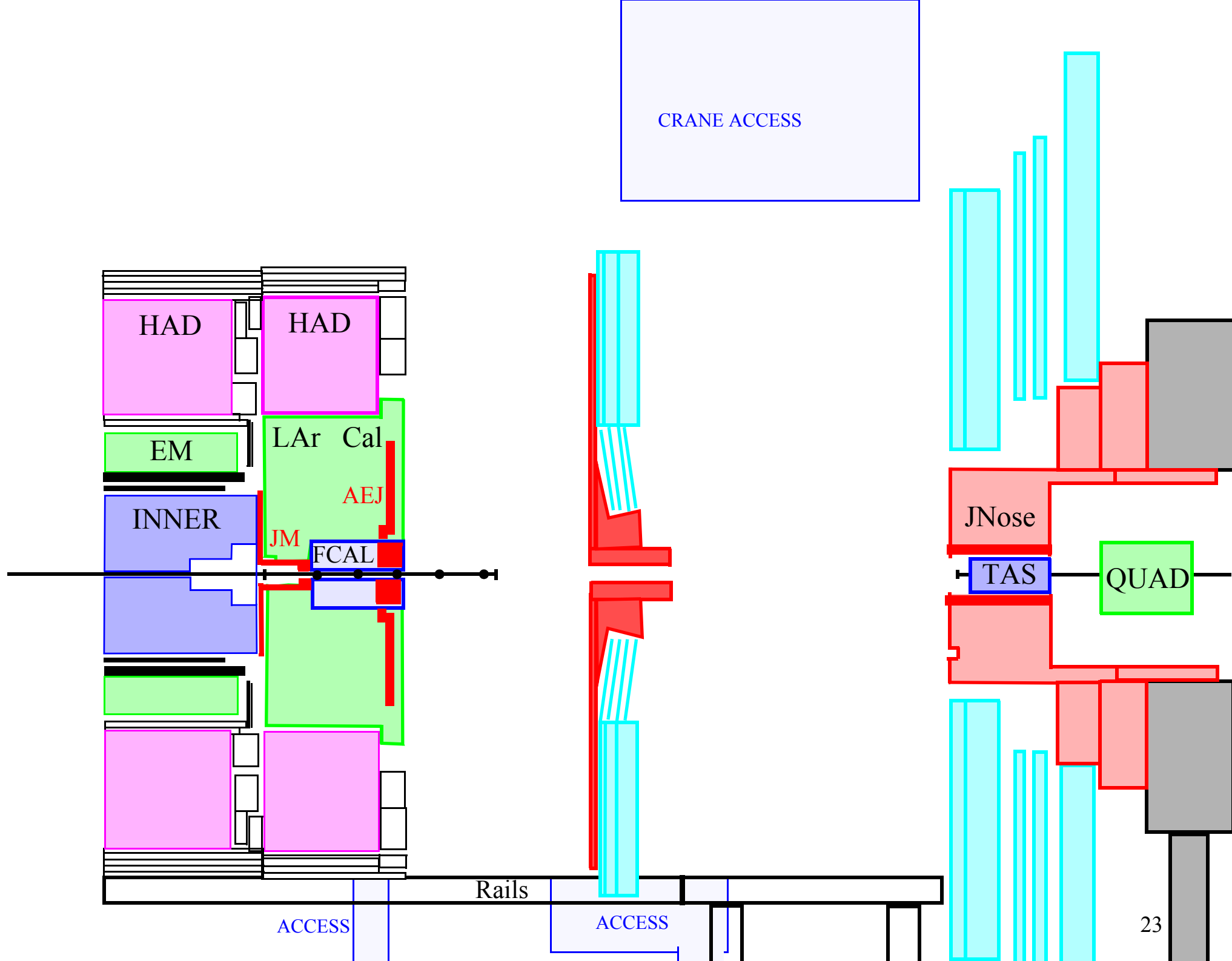

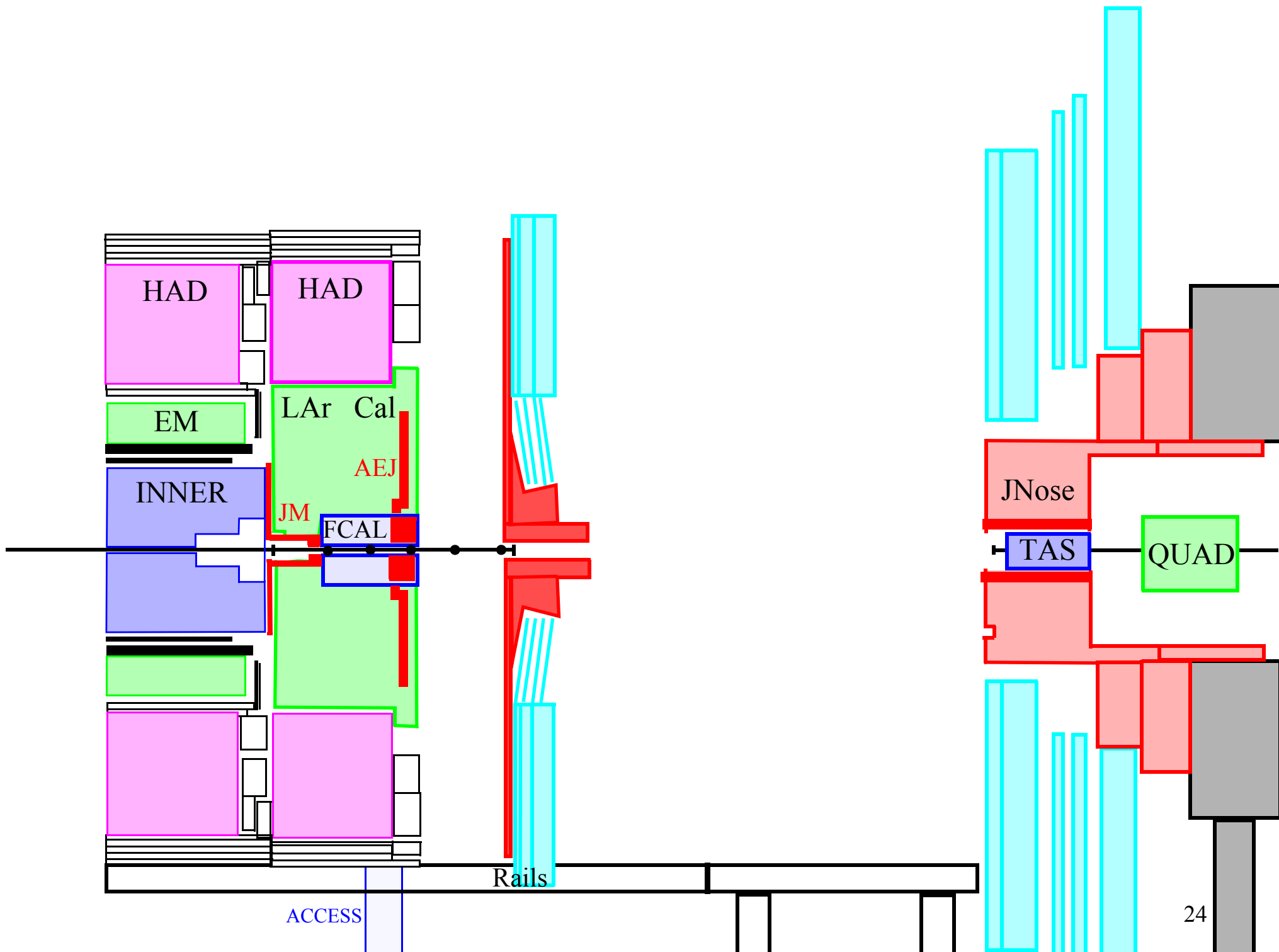

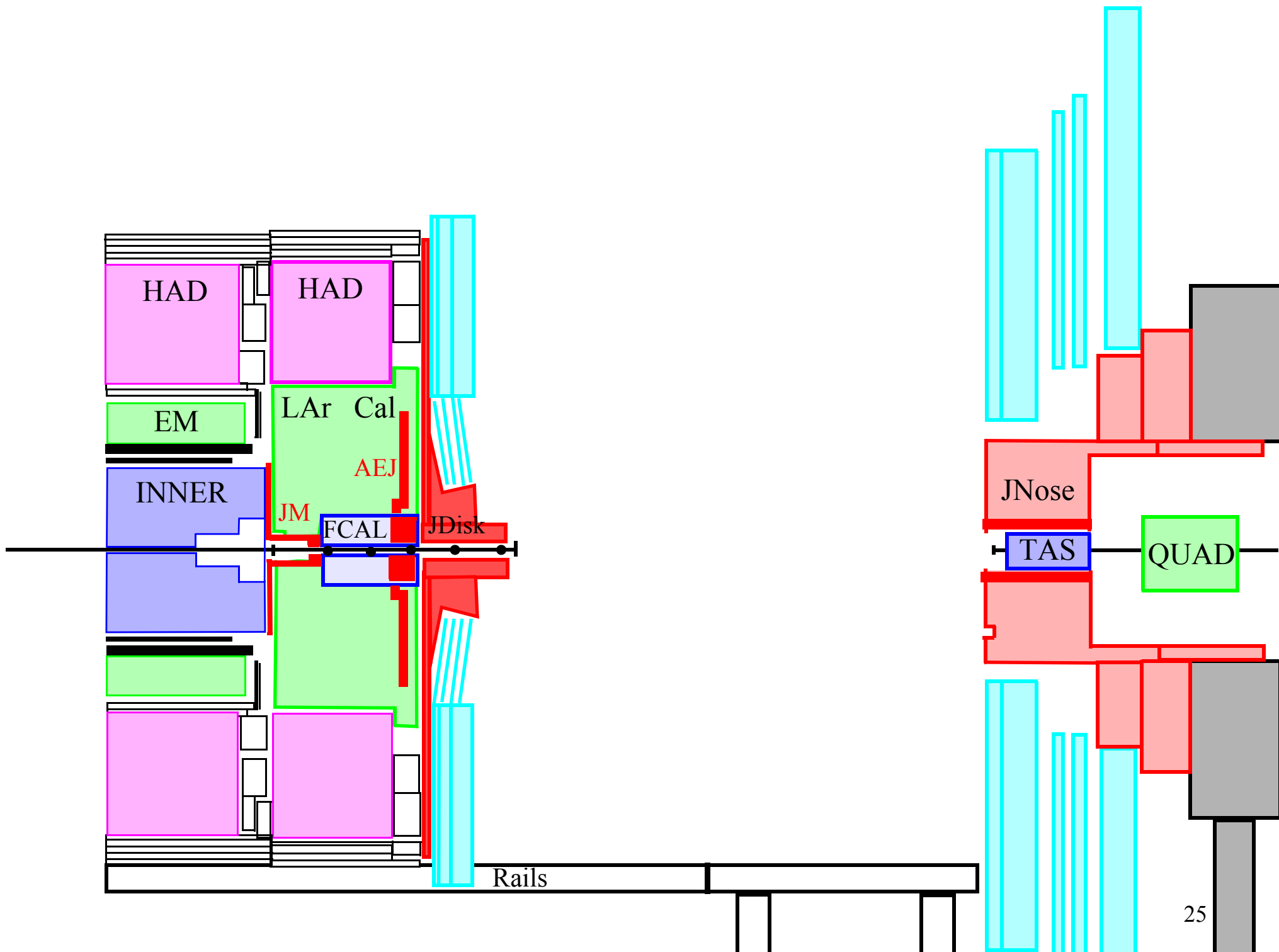

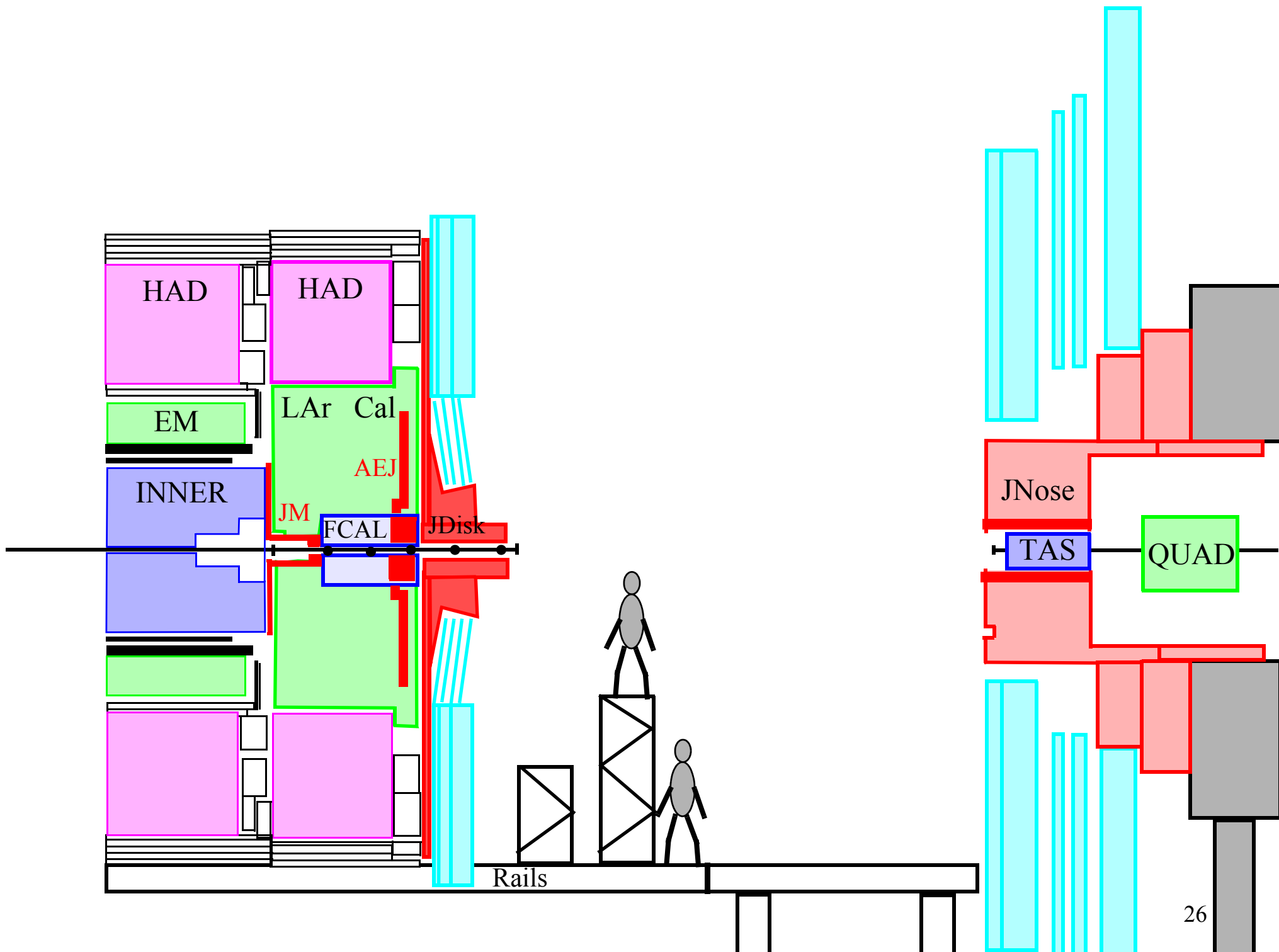

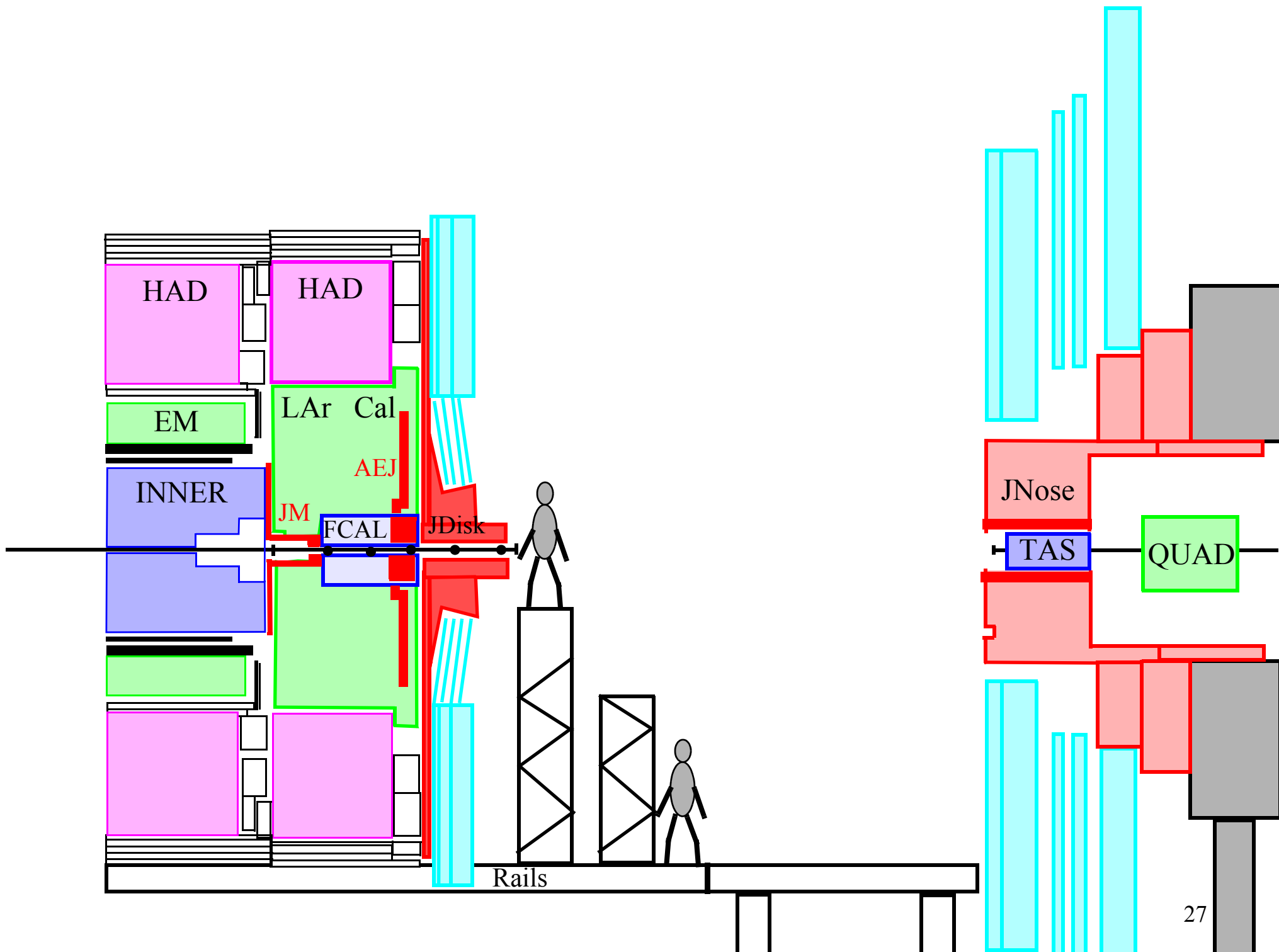

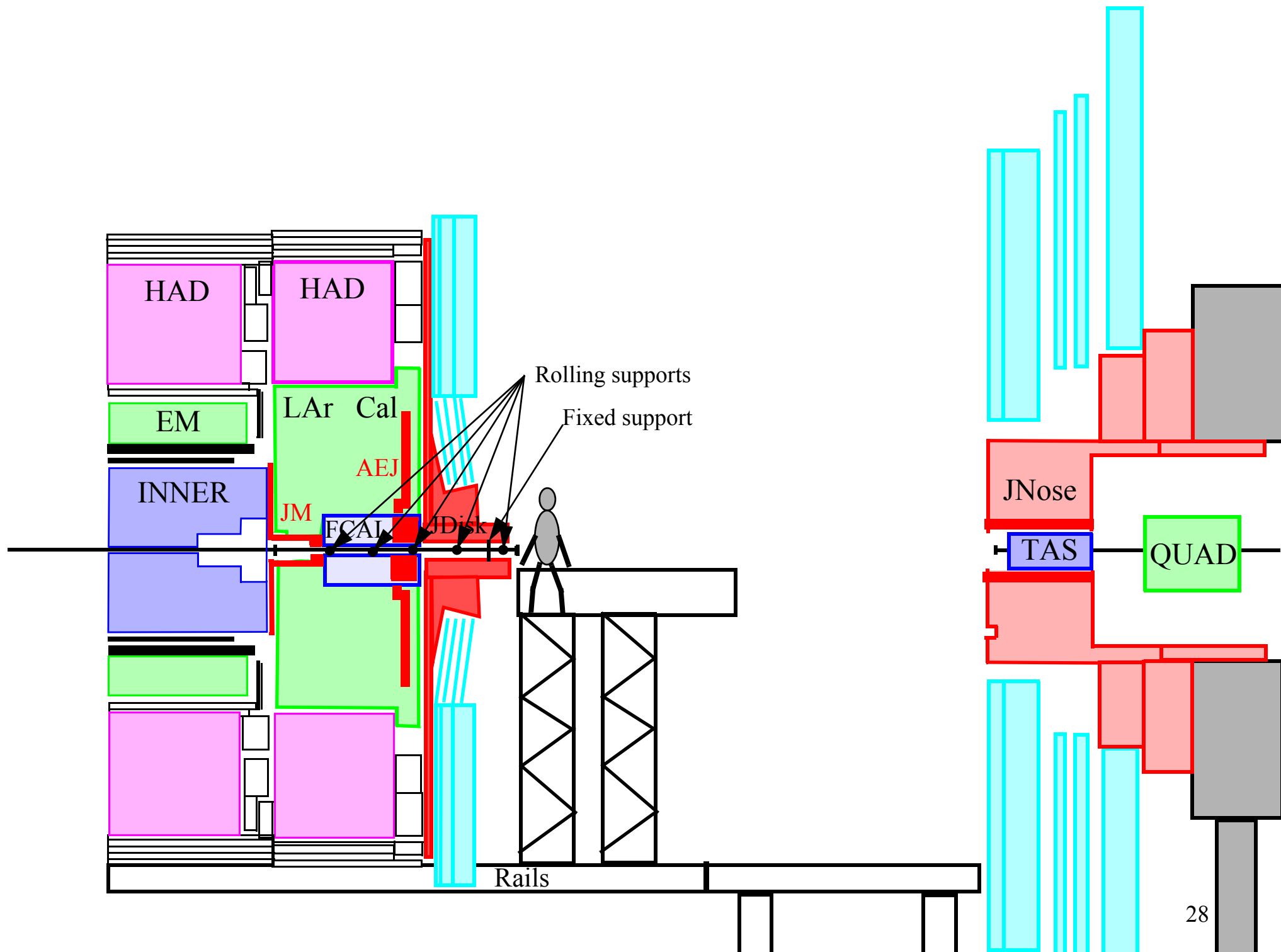

Beampipe supports

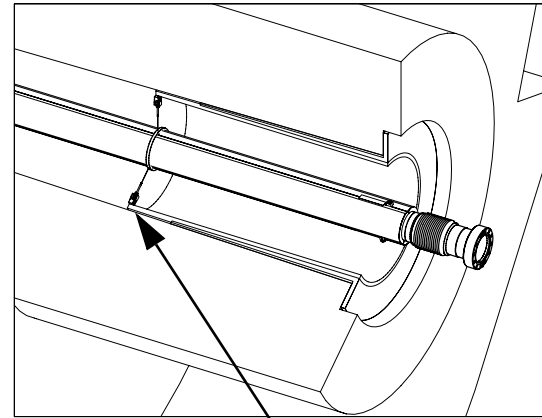
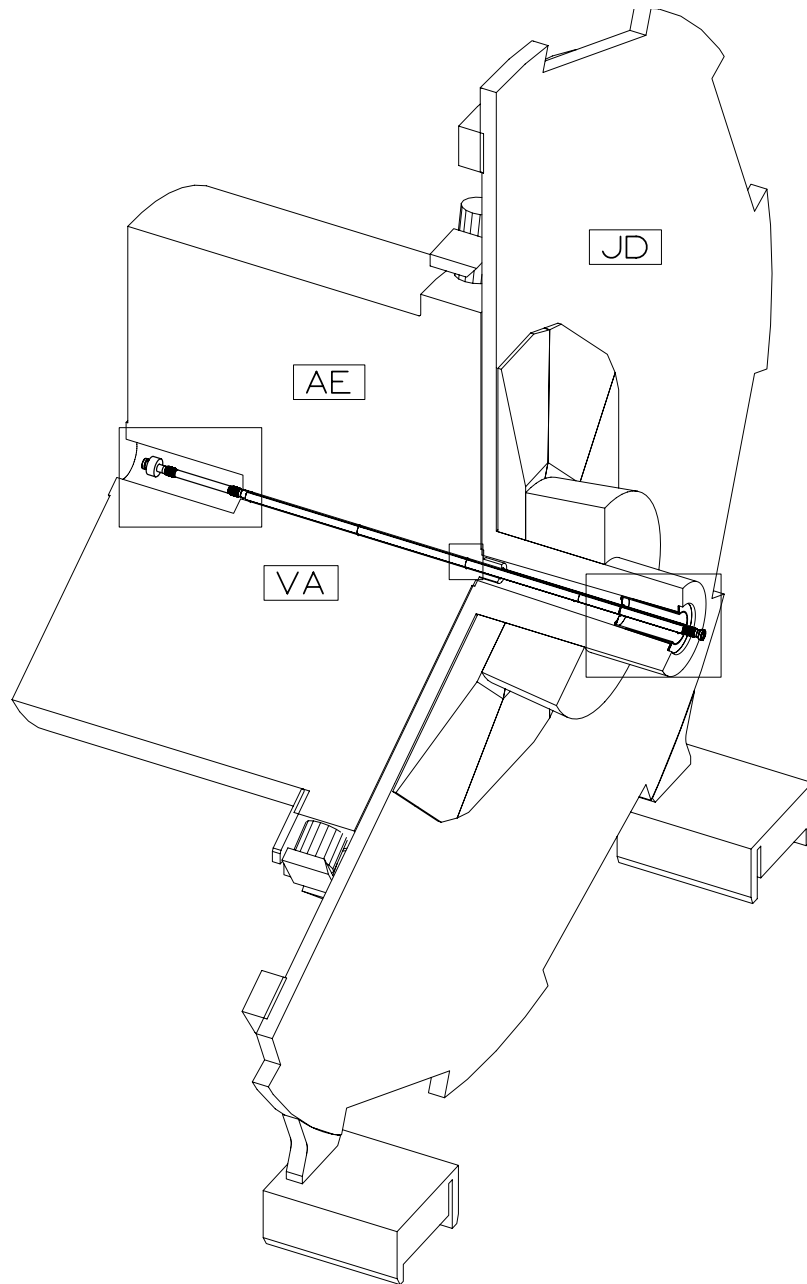

This support has to be attached.

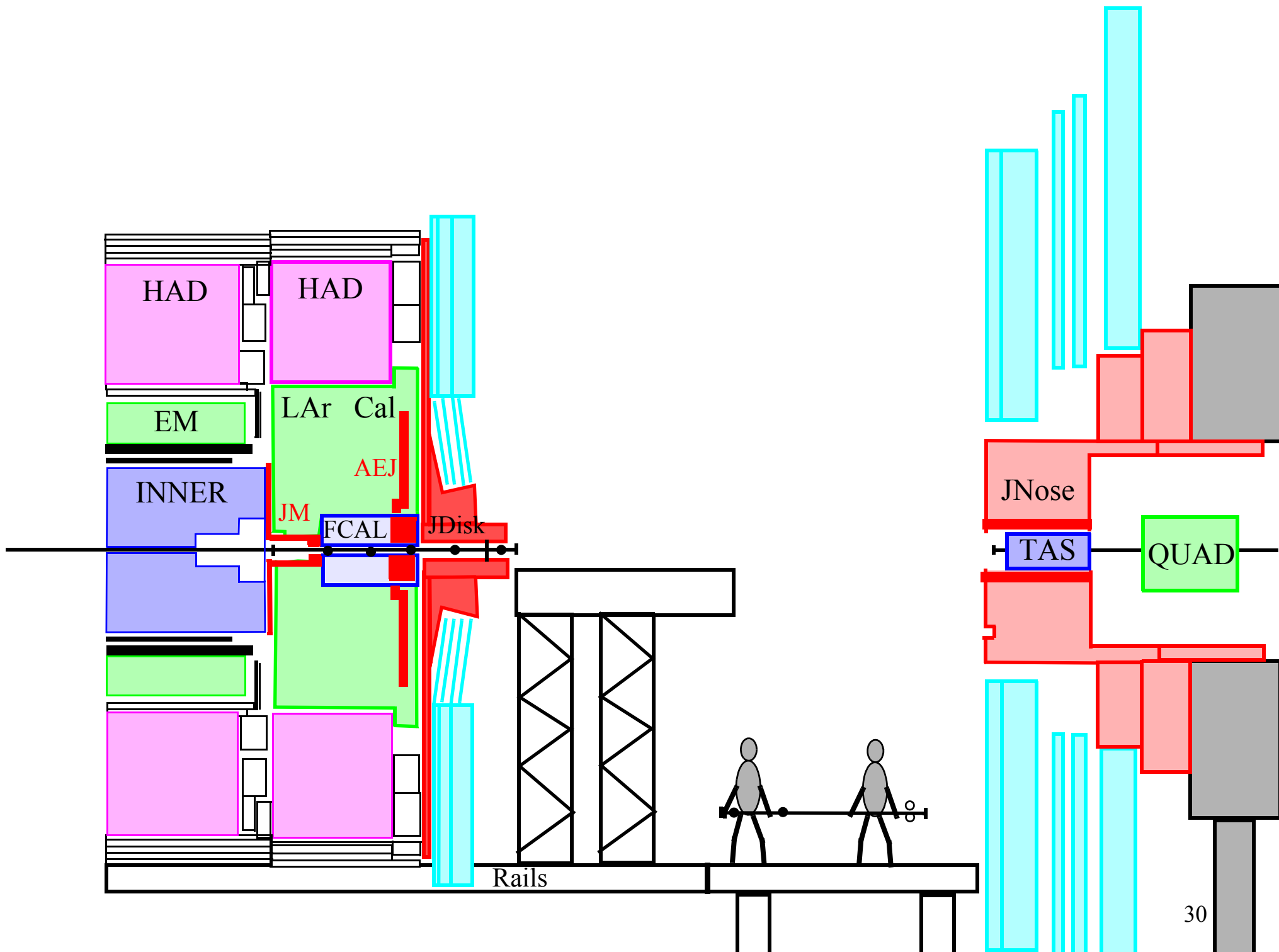

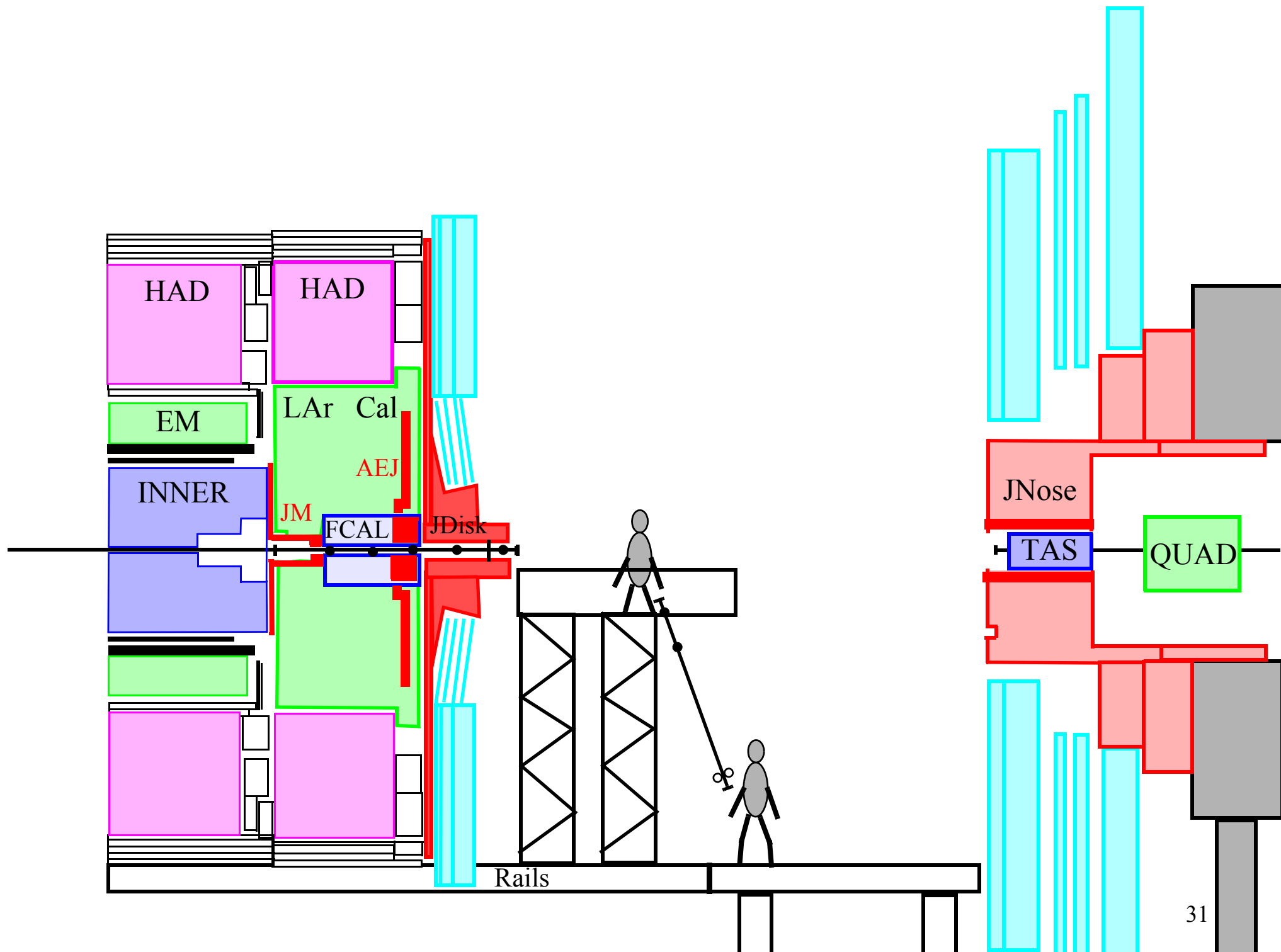

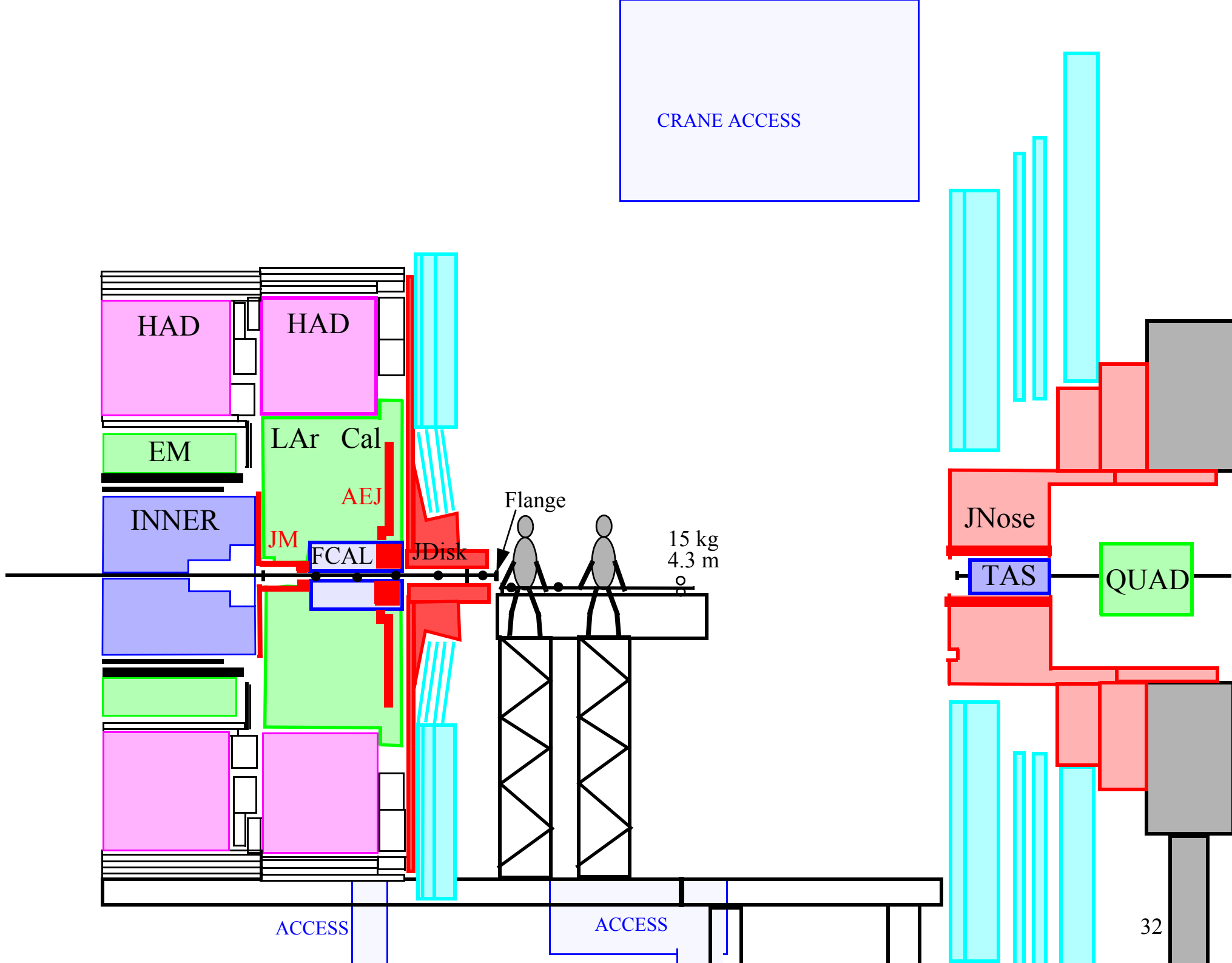

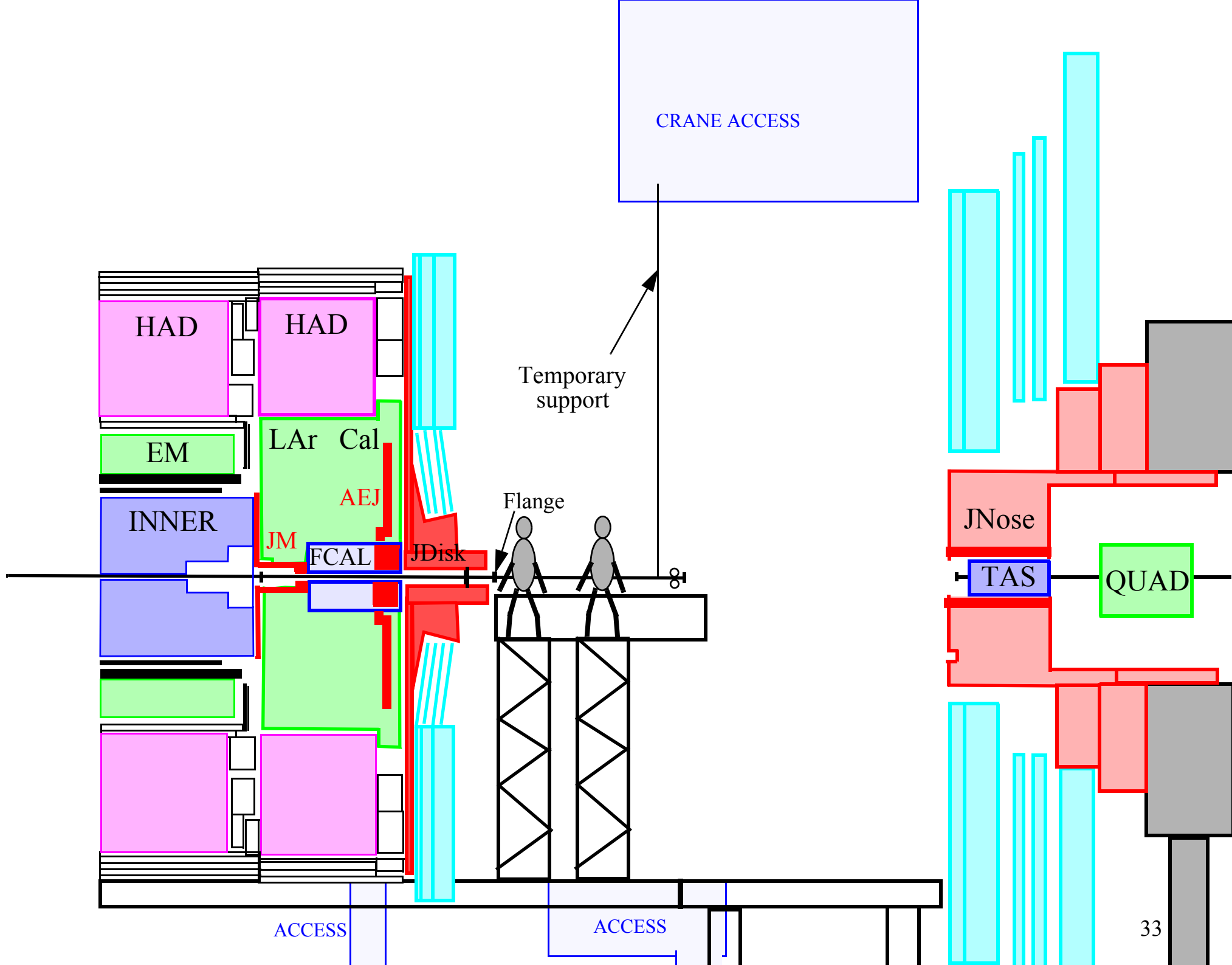

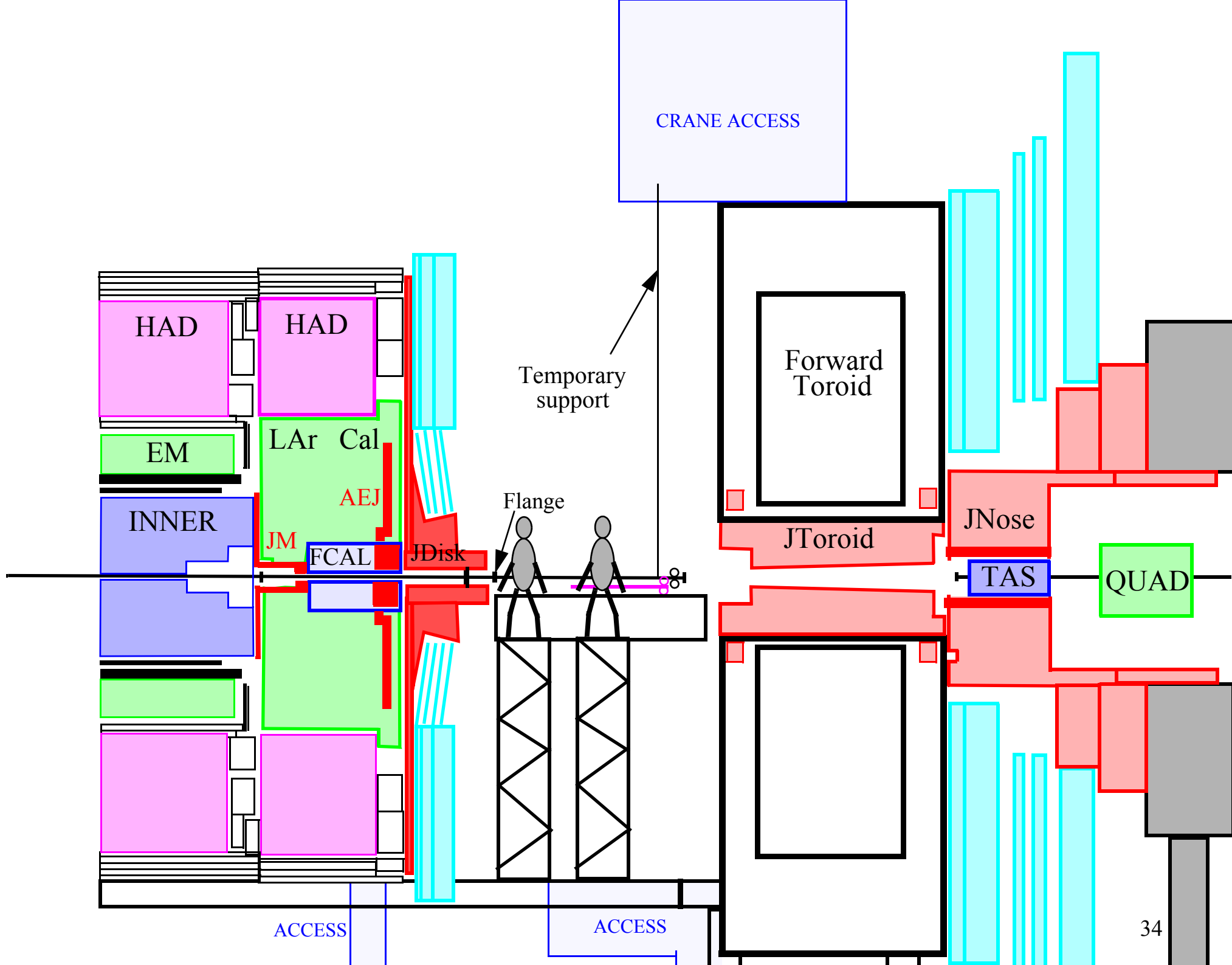

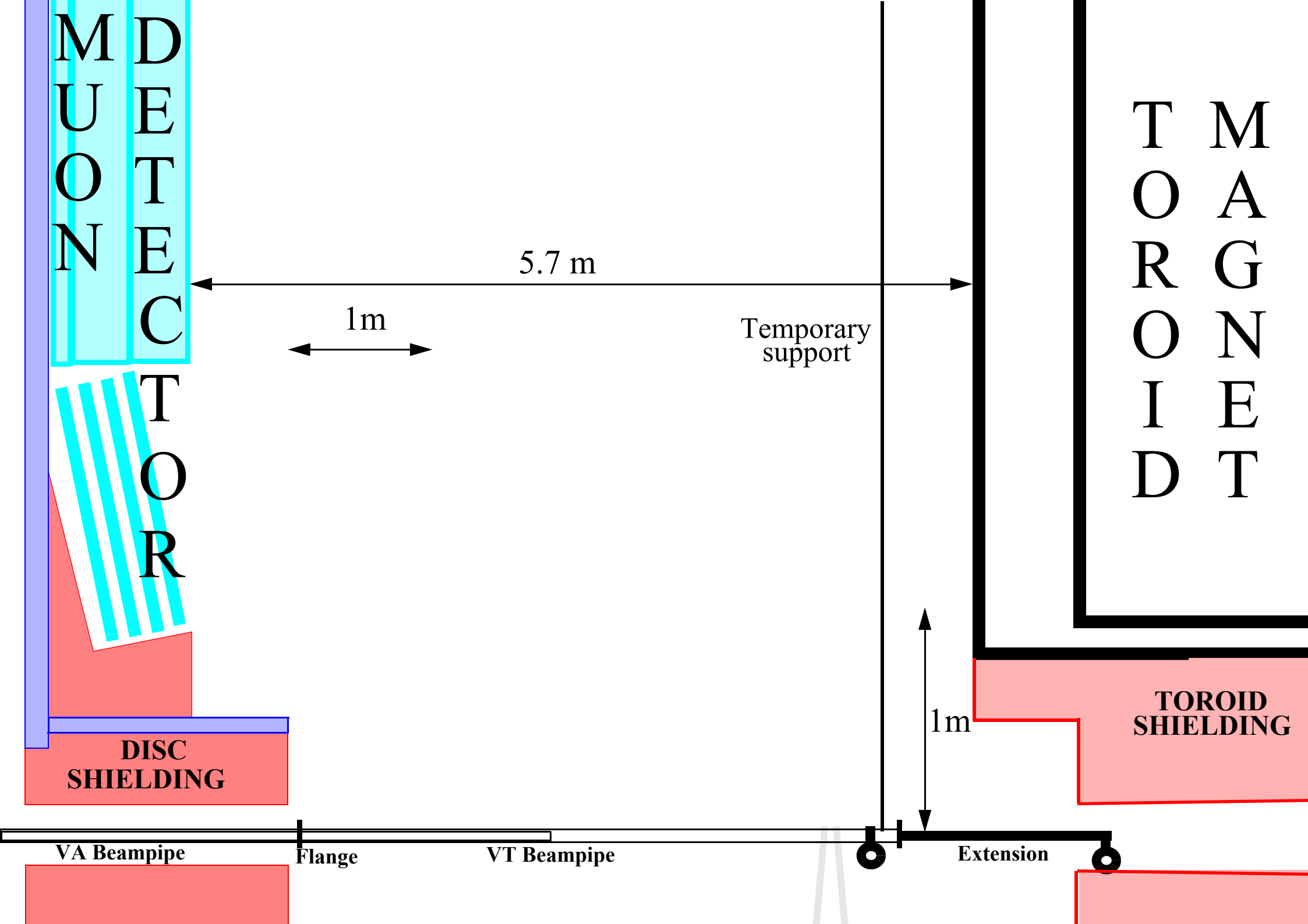

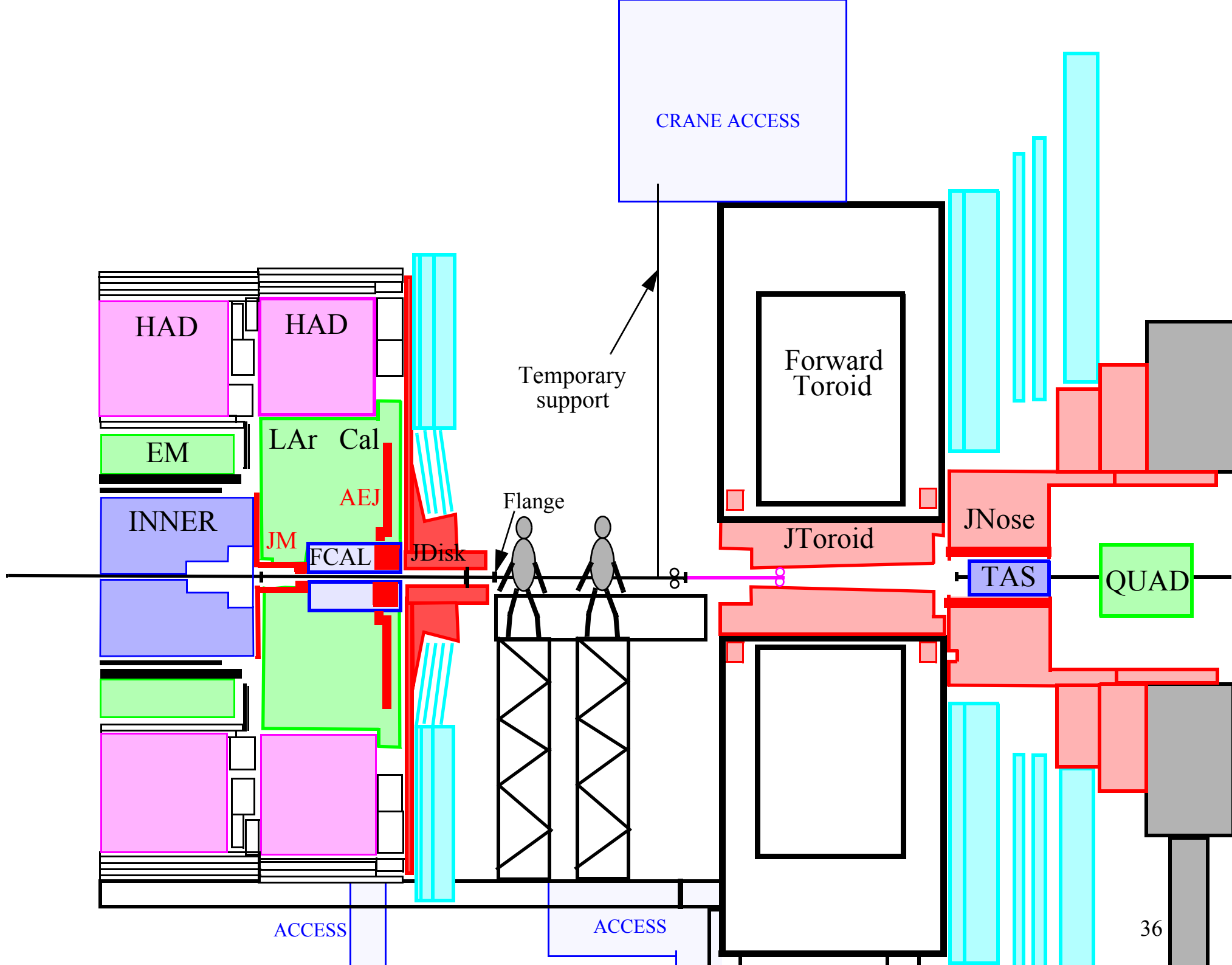

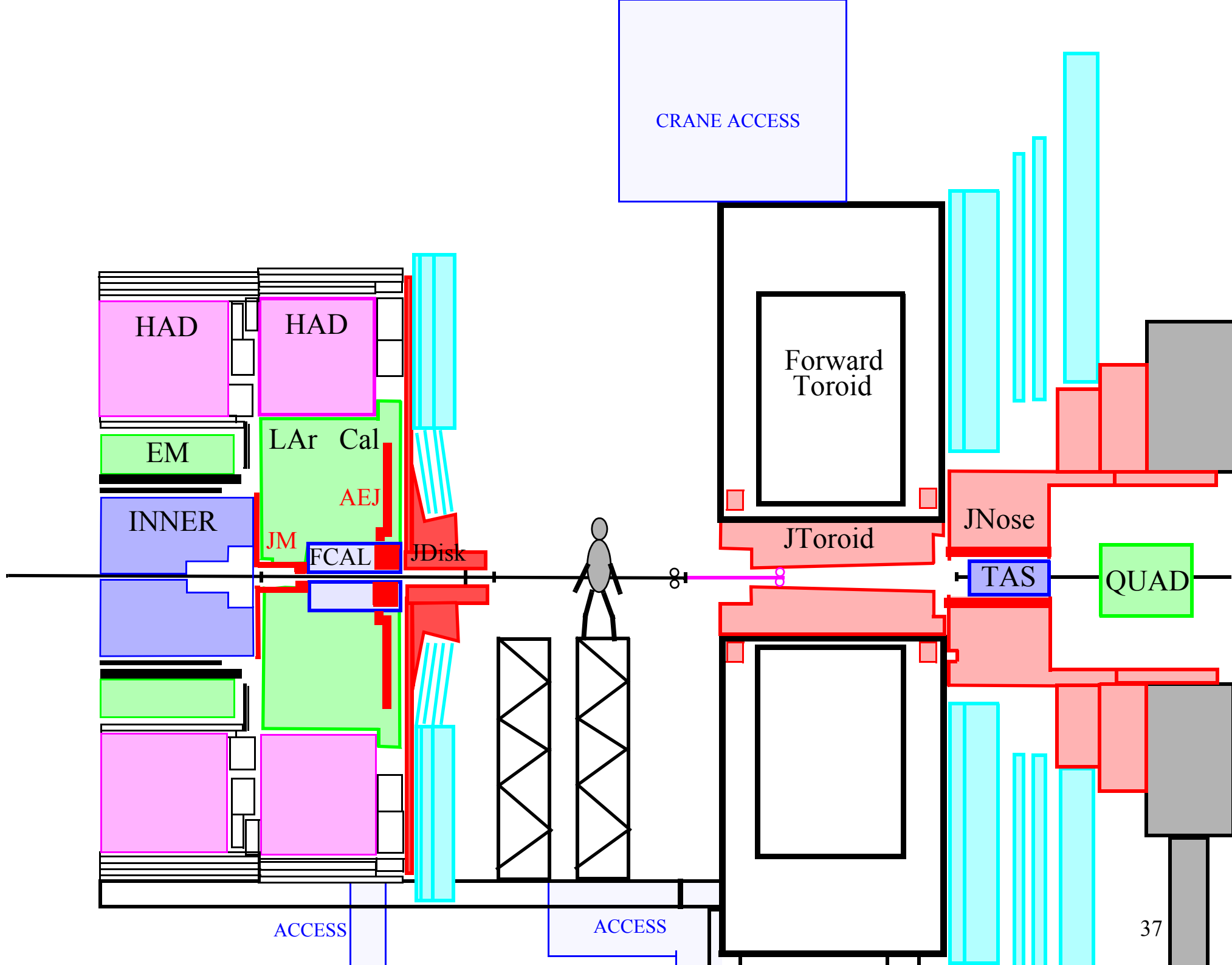

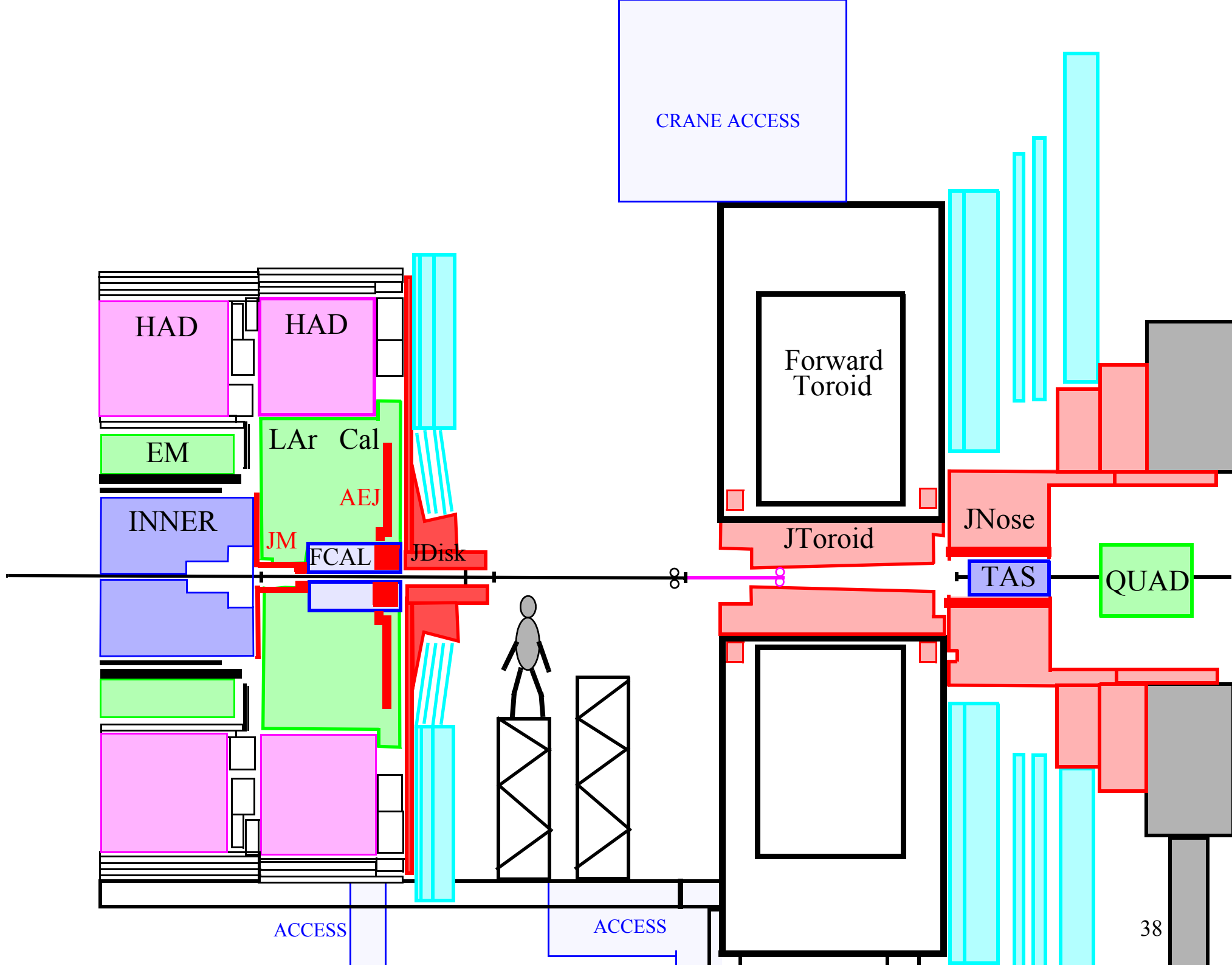

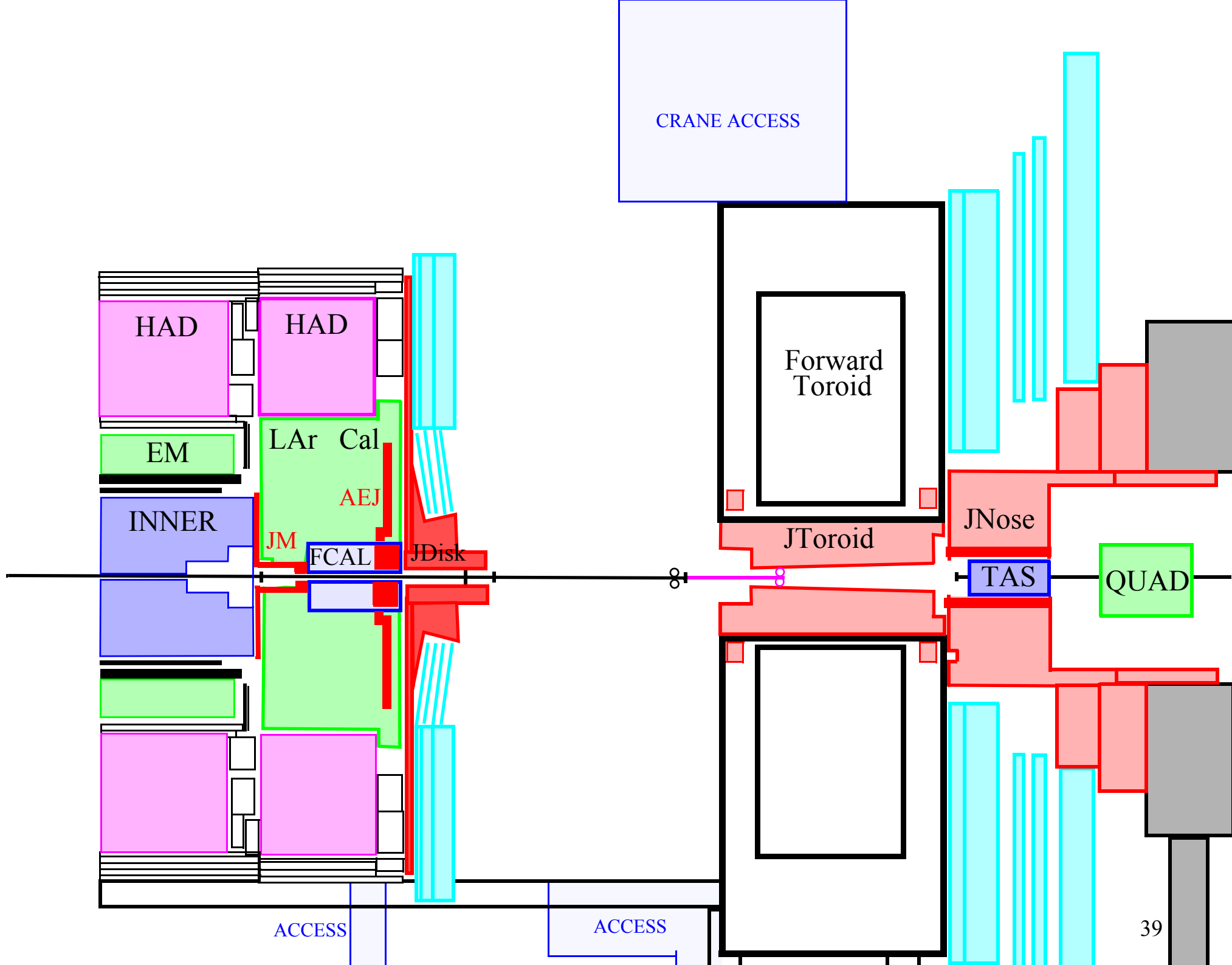

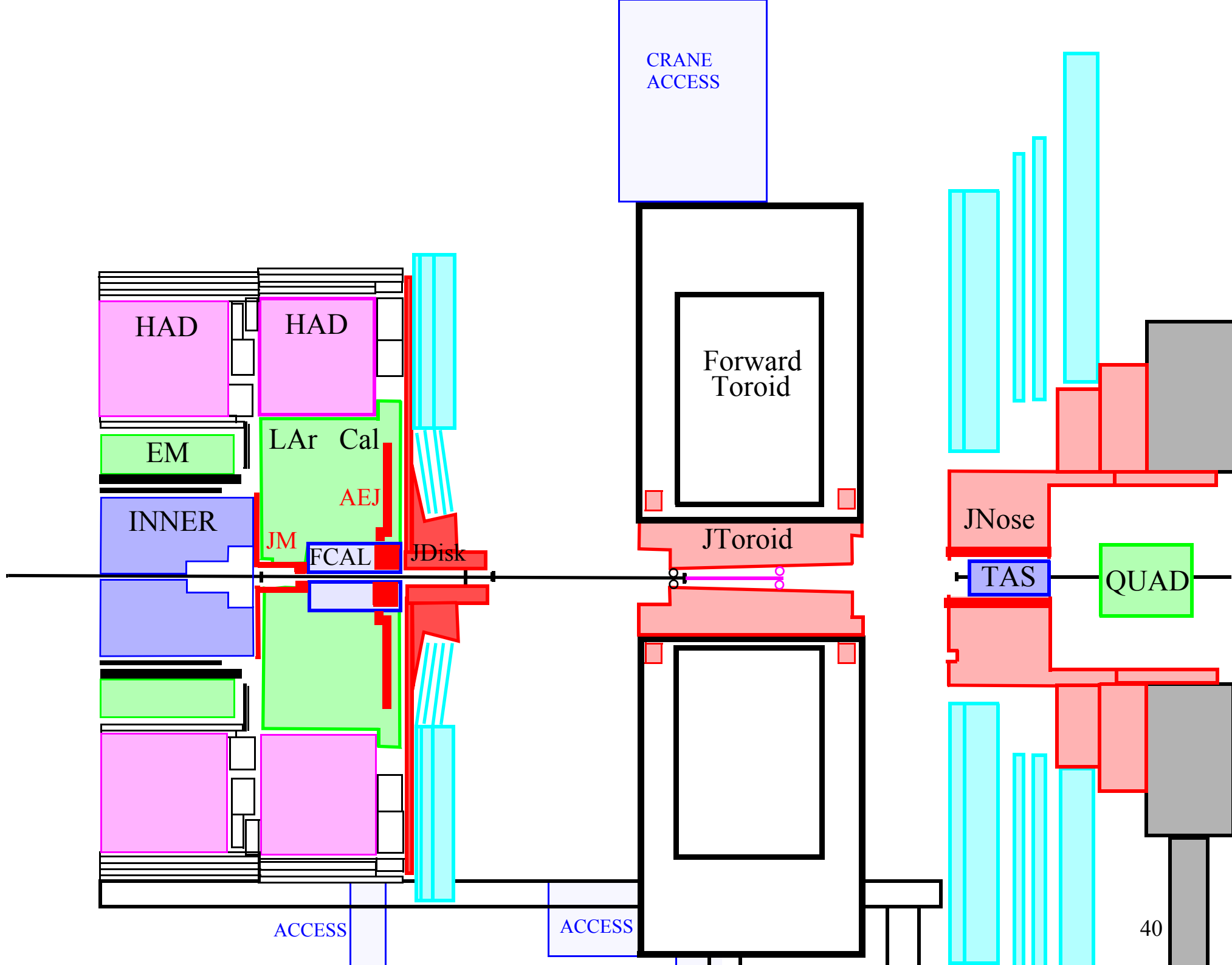

CRANE
ACCESS

Forward
Toroid

JToroid

HAD

HAD

EM

LAr Cal

AEJ

INNER

JM

FCAL

JDisk

JNose

TAS

QUAD

ACCESS

ACCESS

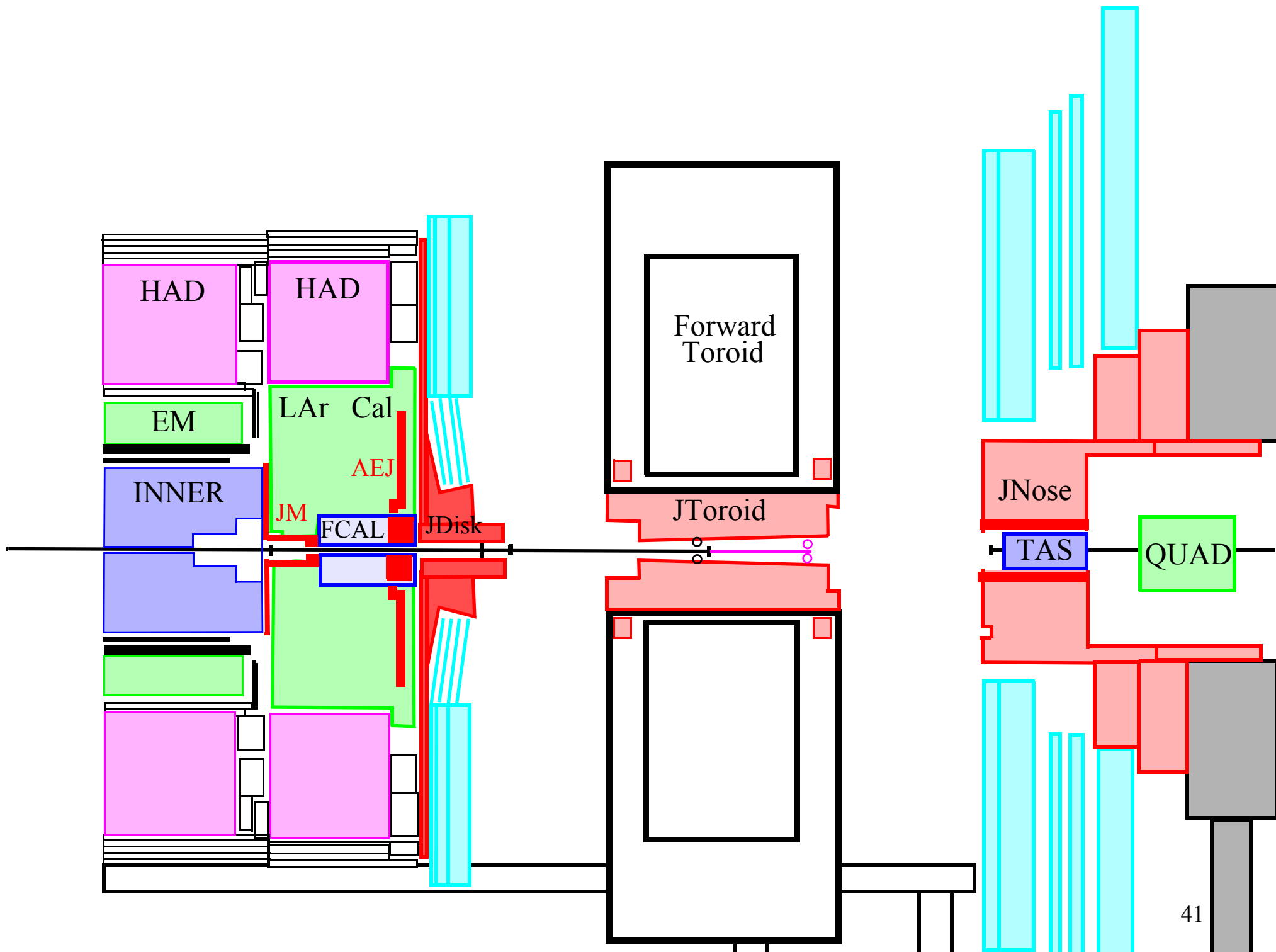

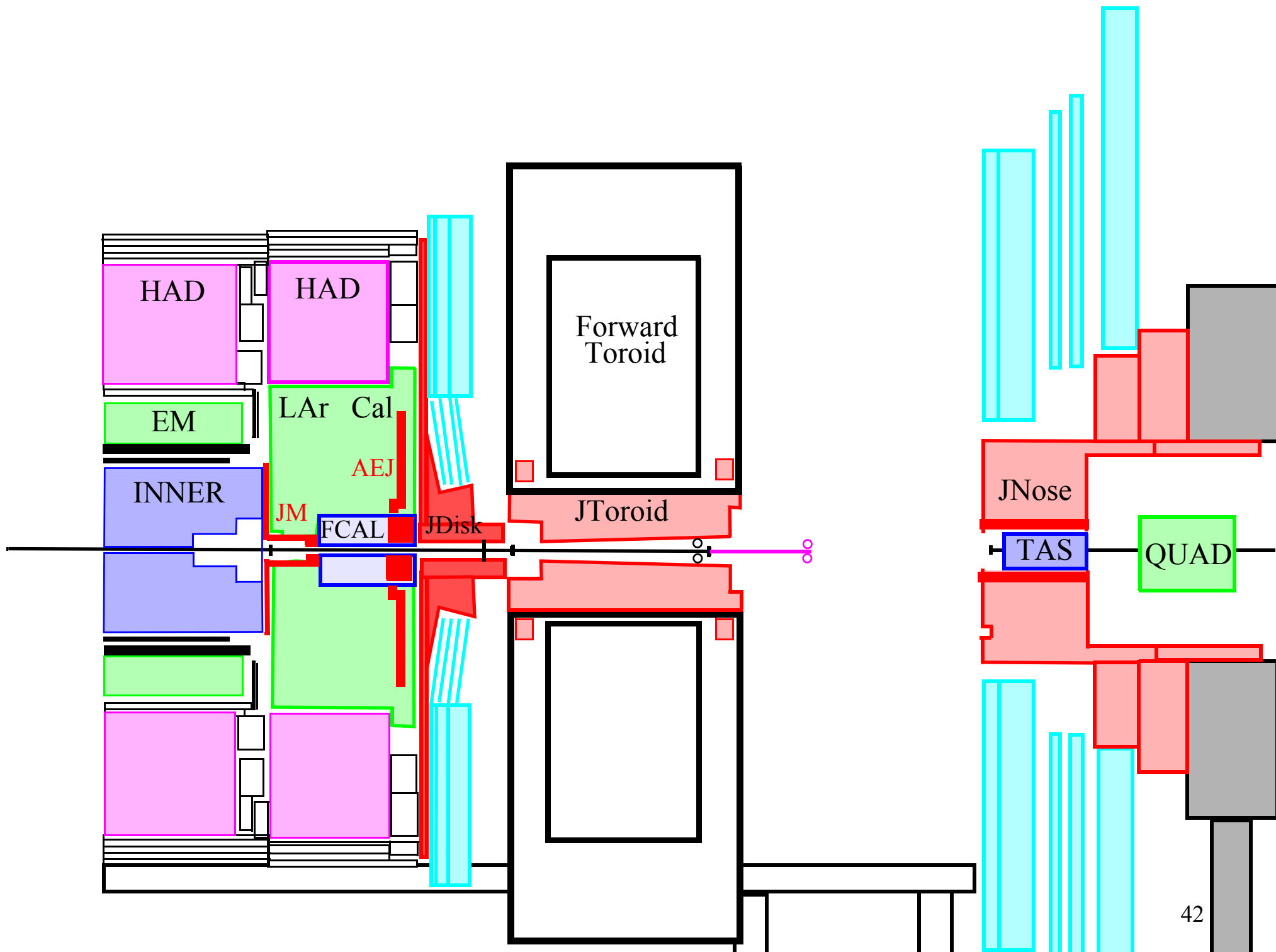

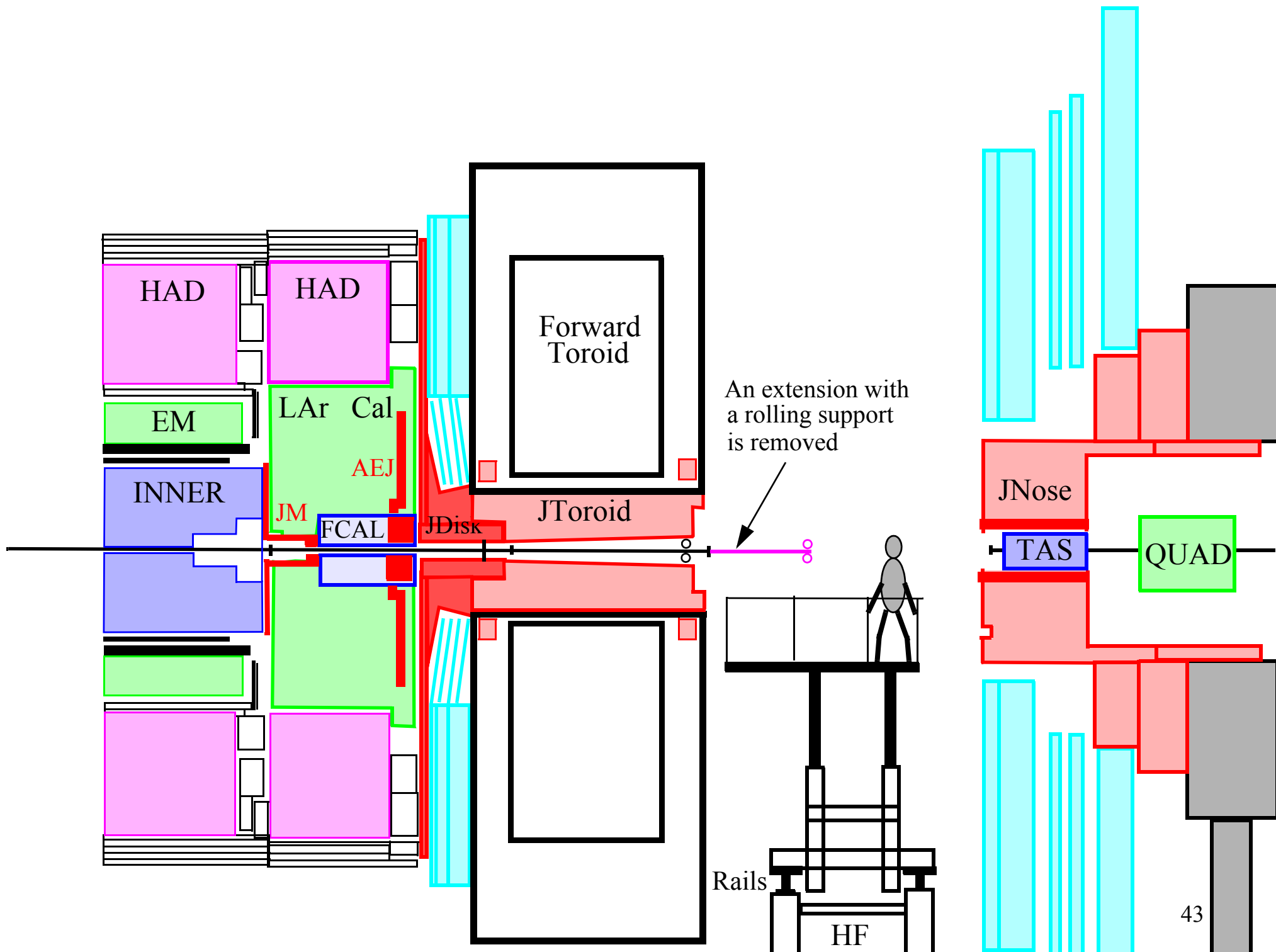

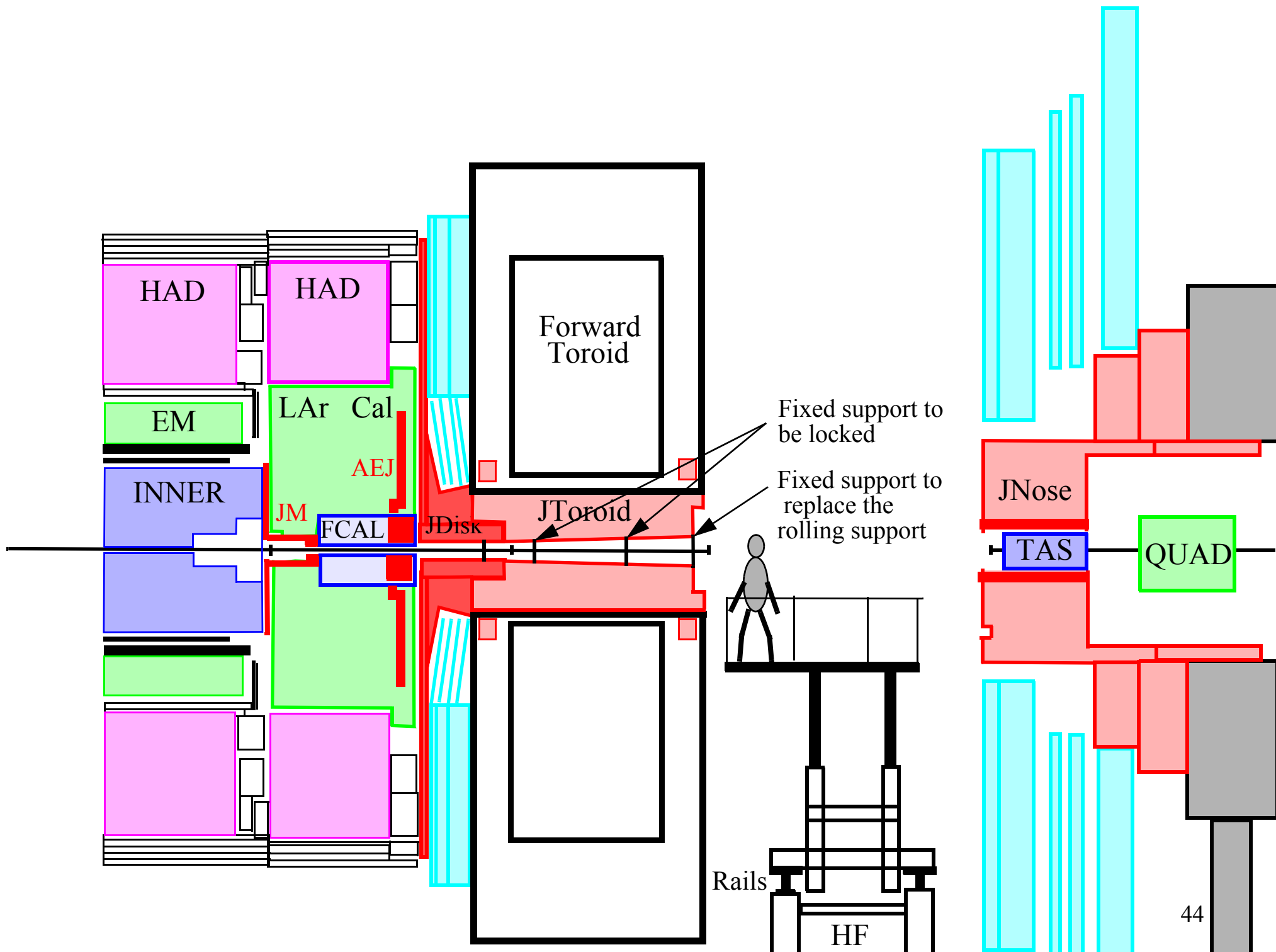

Beampipe supports

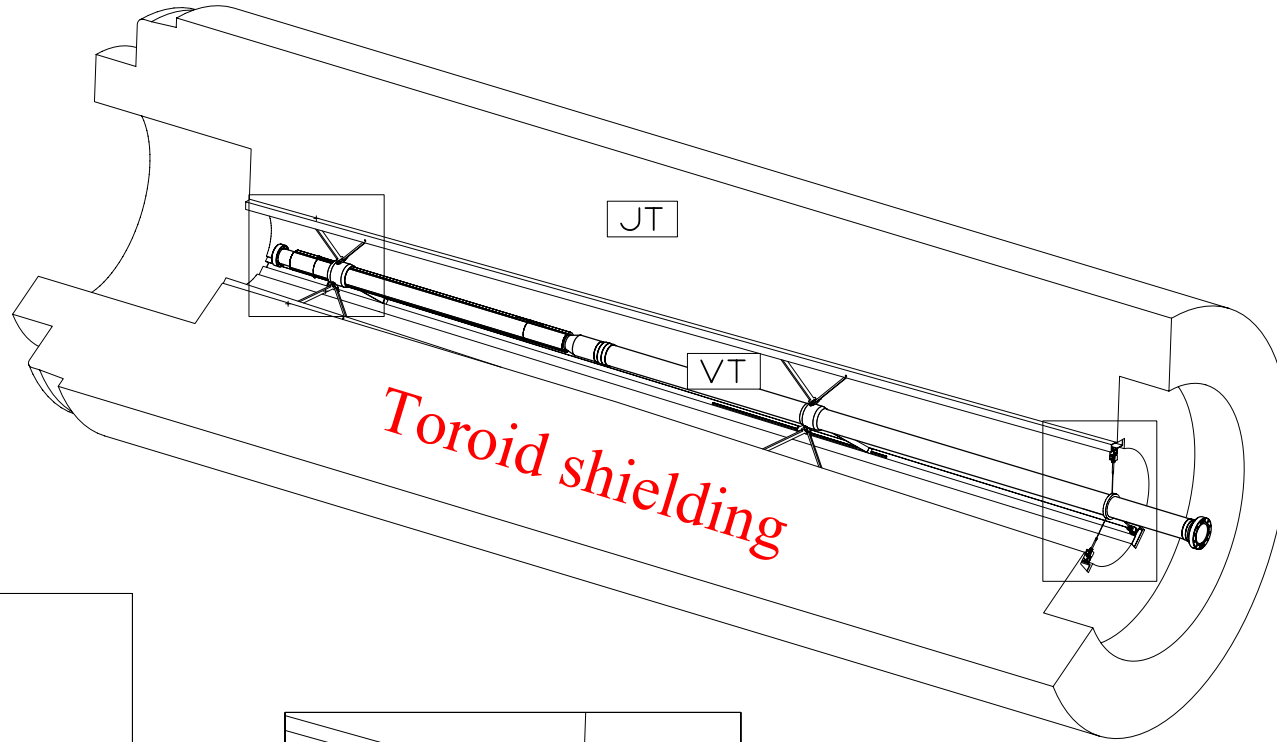

This support has to be locked.

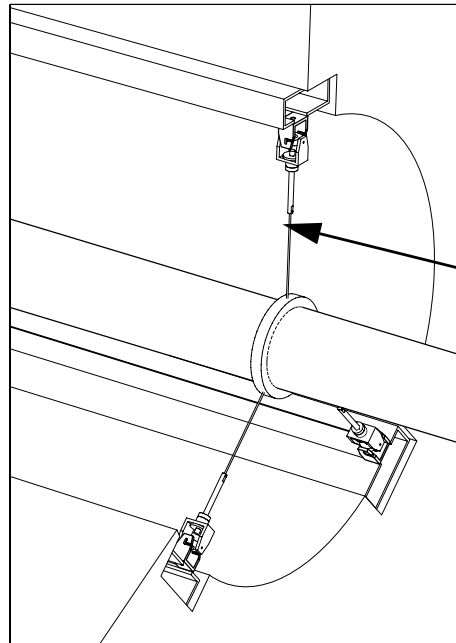
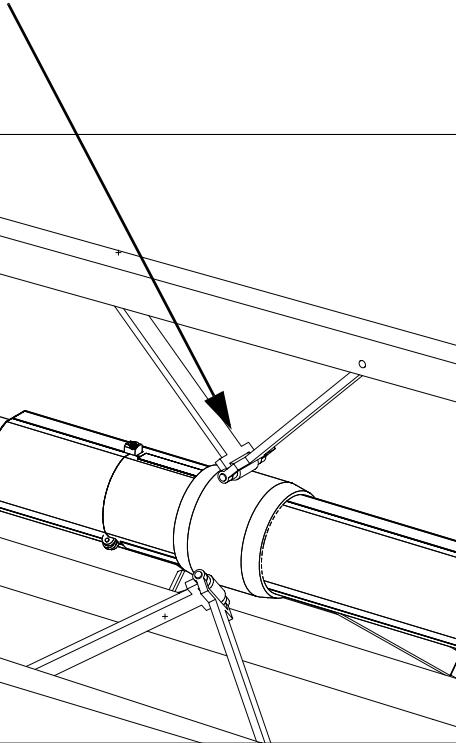

This support has to be attached and the rolling support has to be removed.

