

HAD

EM

INNER

HAD

LAr Cal

FCAL

JNose

TAS

QUAD

AEJ

JM

Rails

ACCESS

8

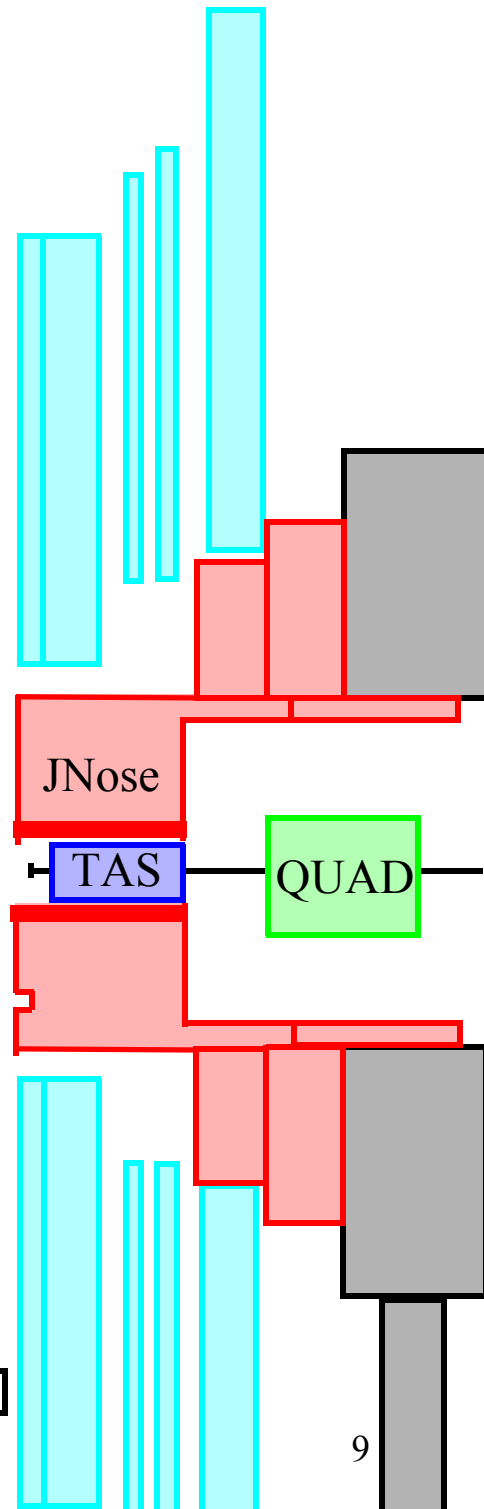
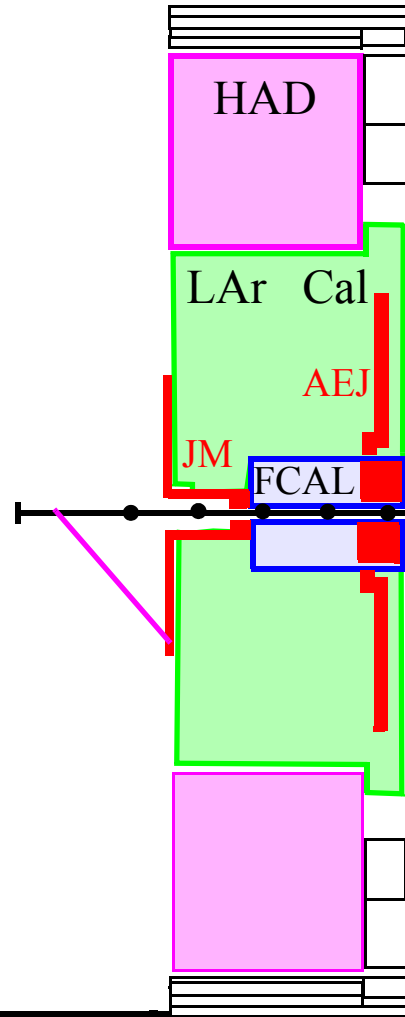
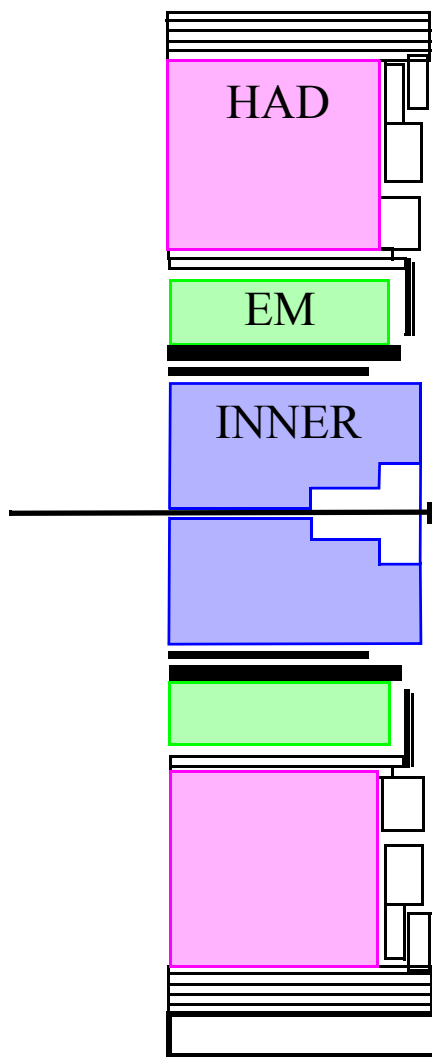

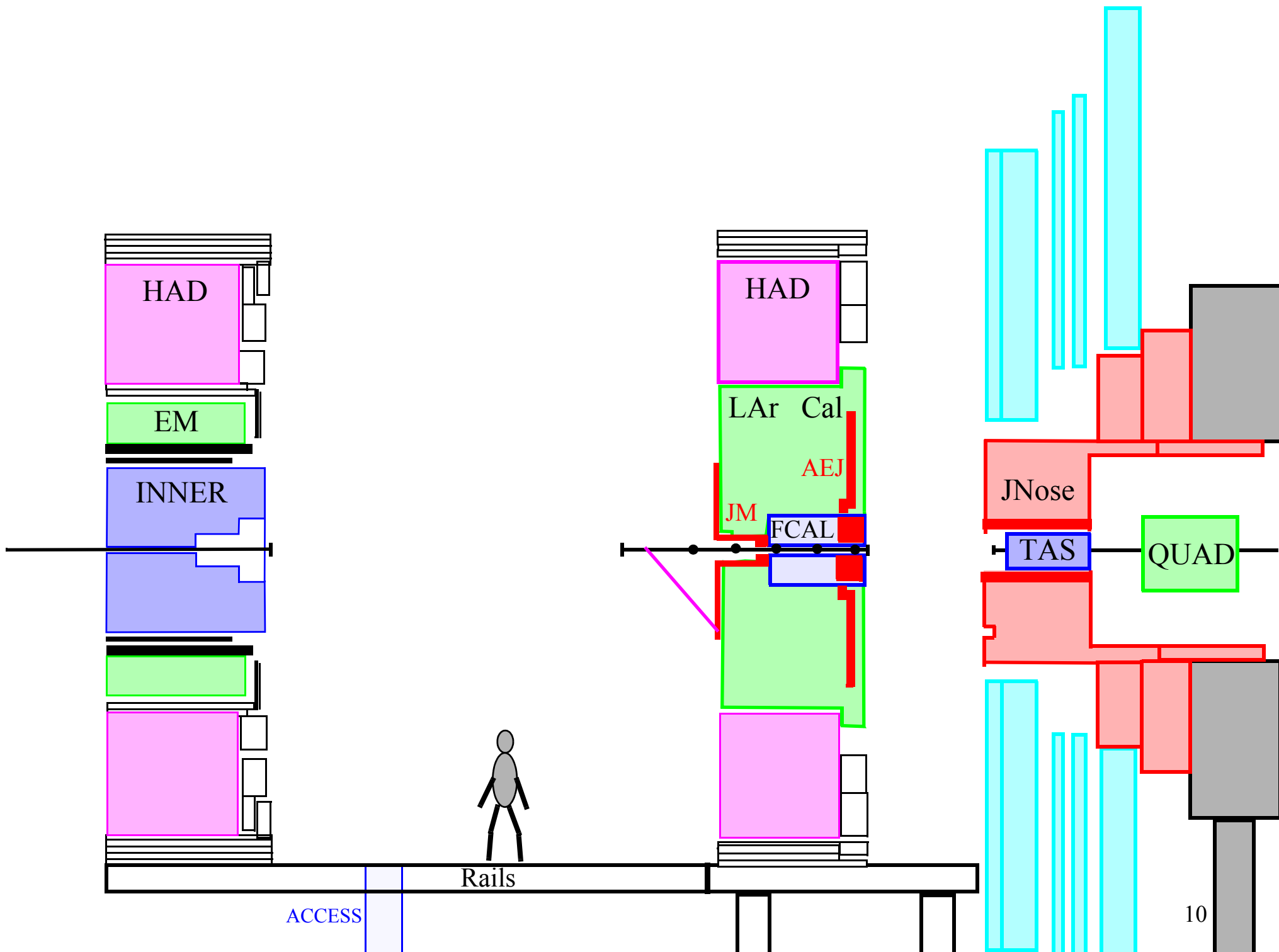

HAD

EM

INNER

HAD

LAr Cal

AEJ

JM

FCAL

JNose

TAS

QUAD

ACCESS

RAILS

10

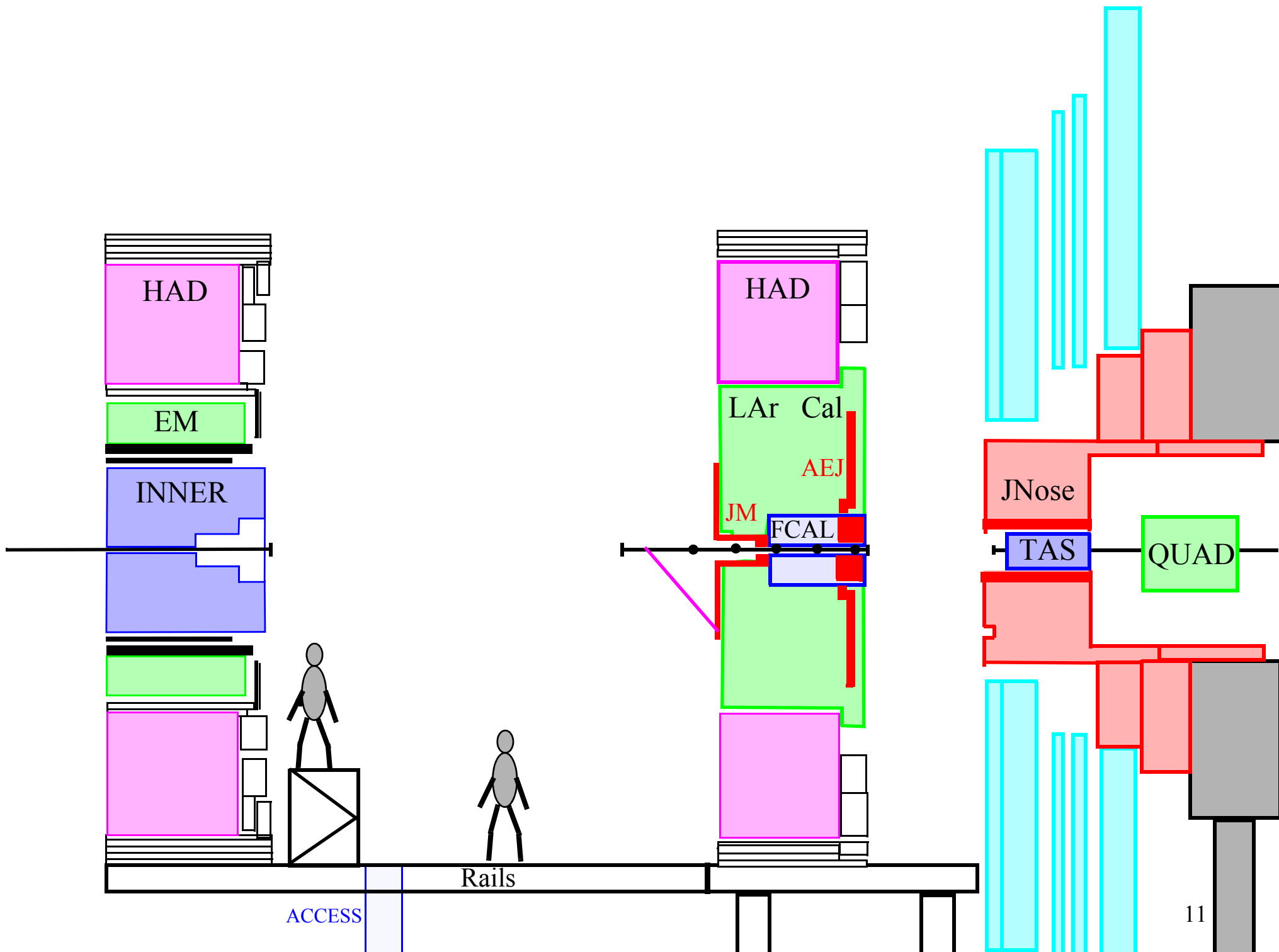

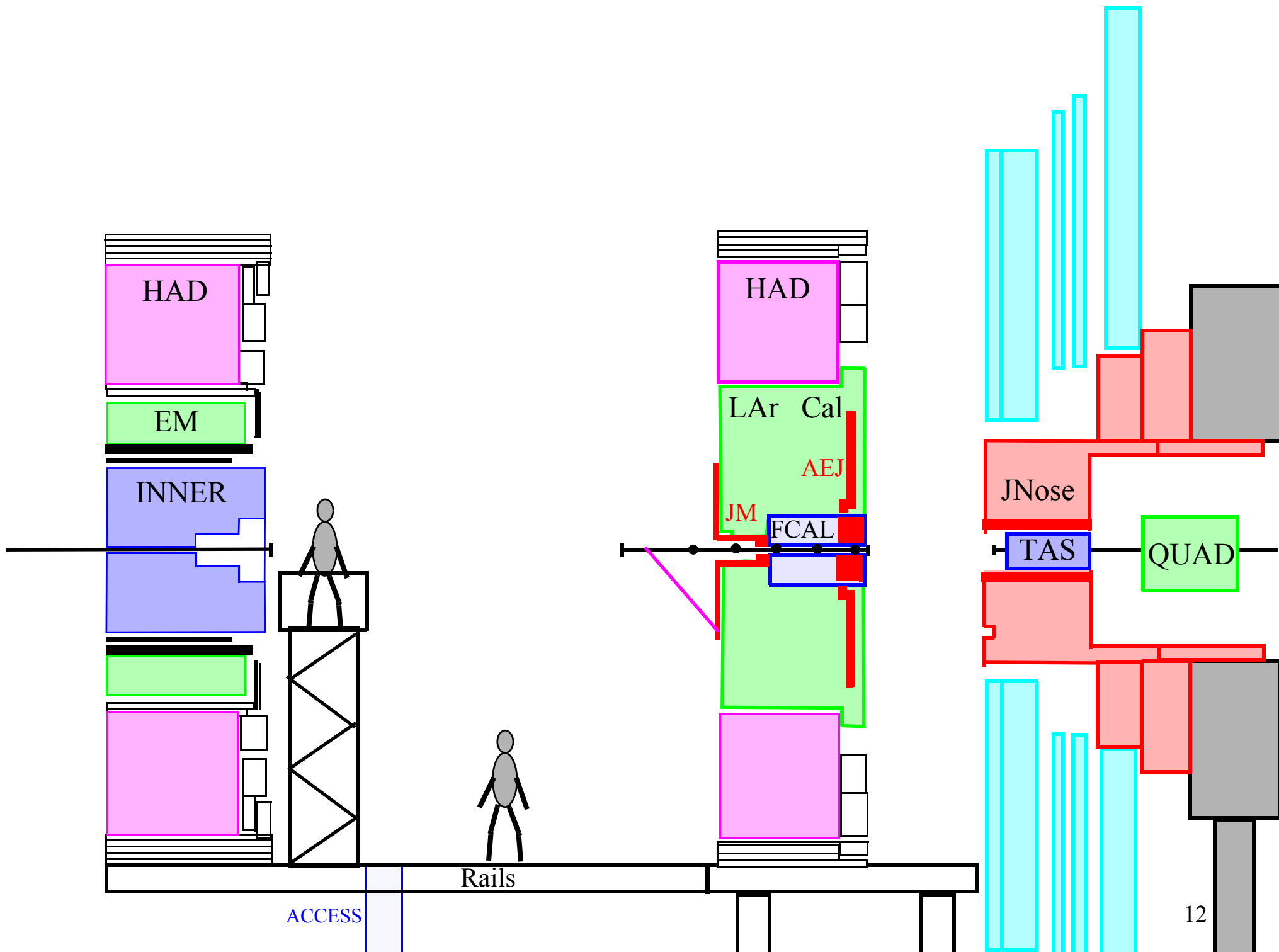

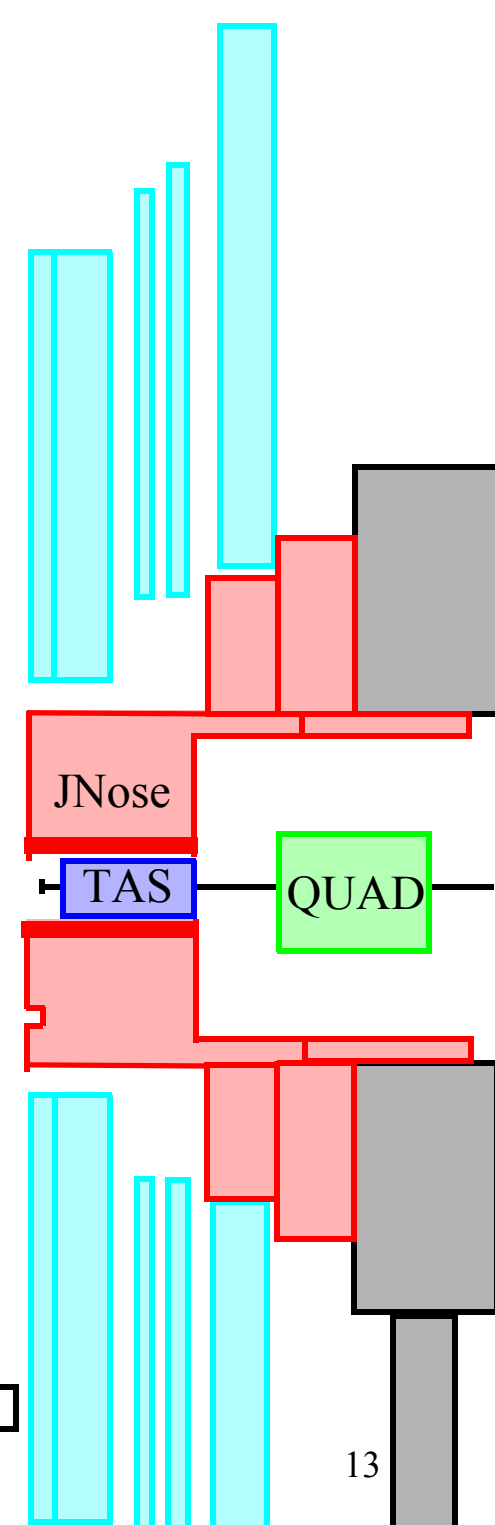
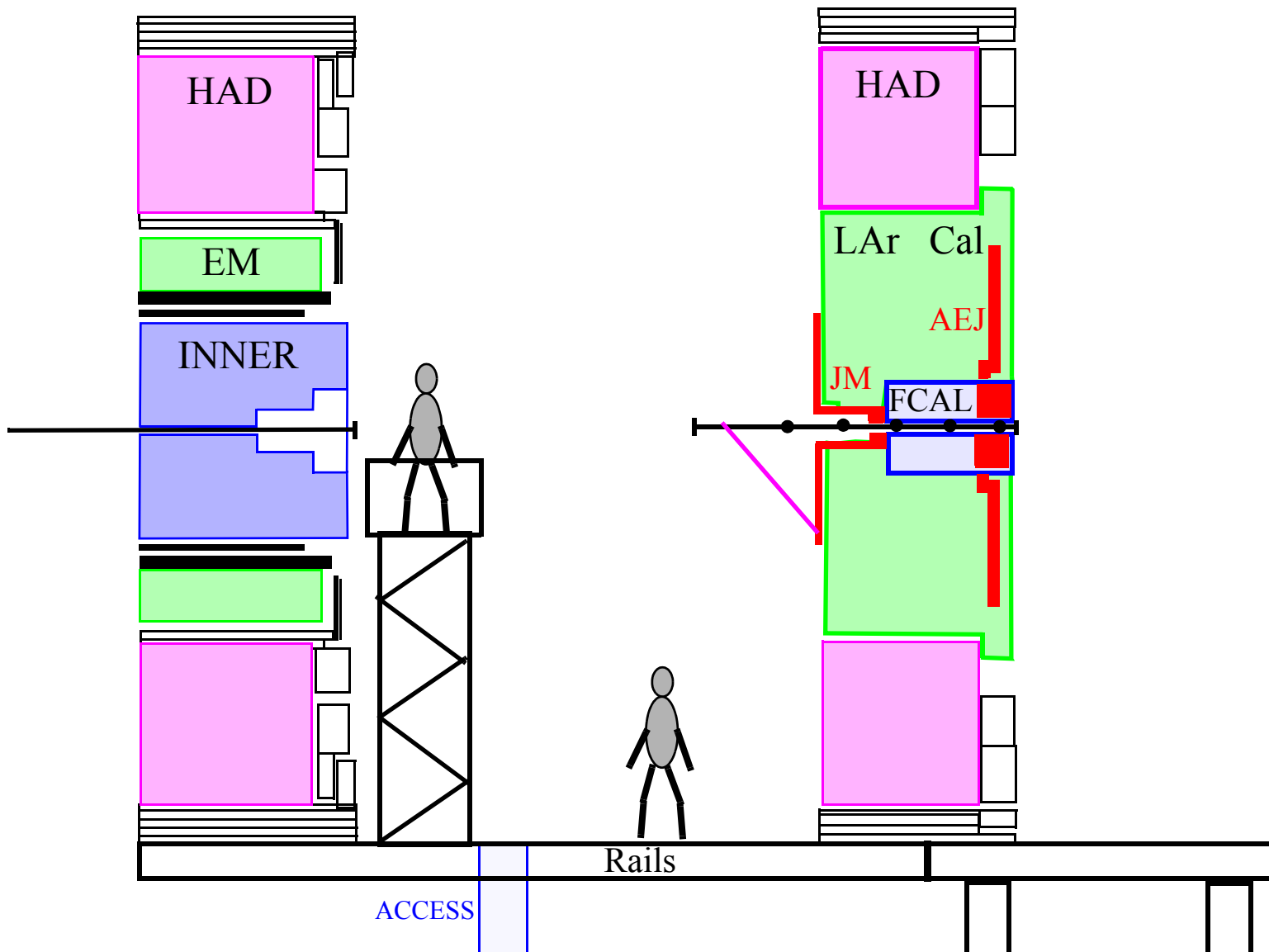

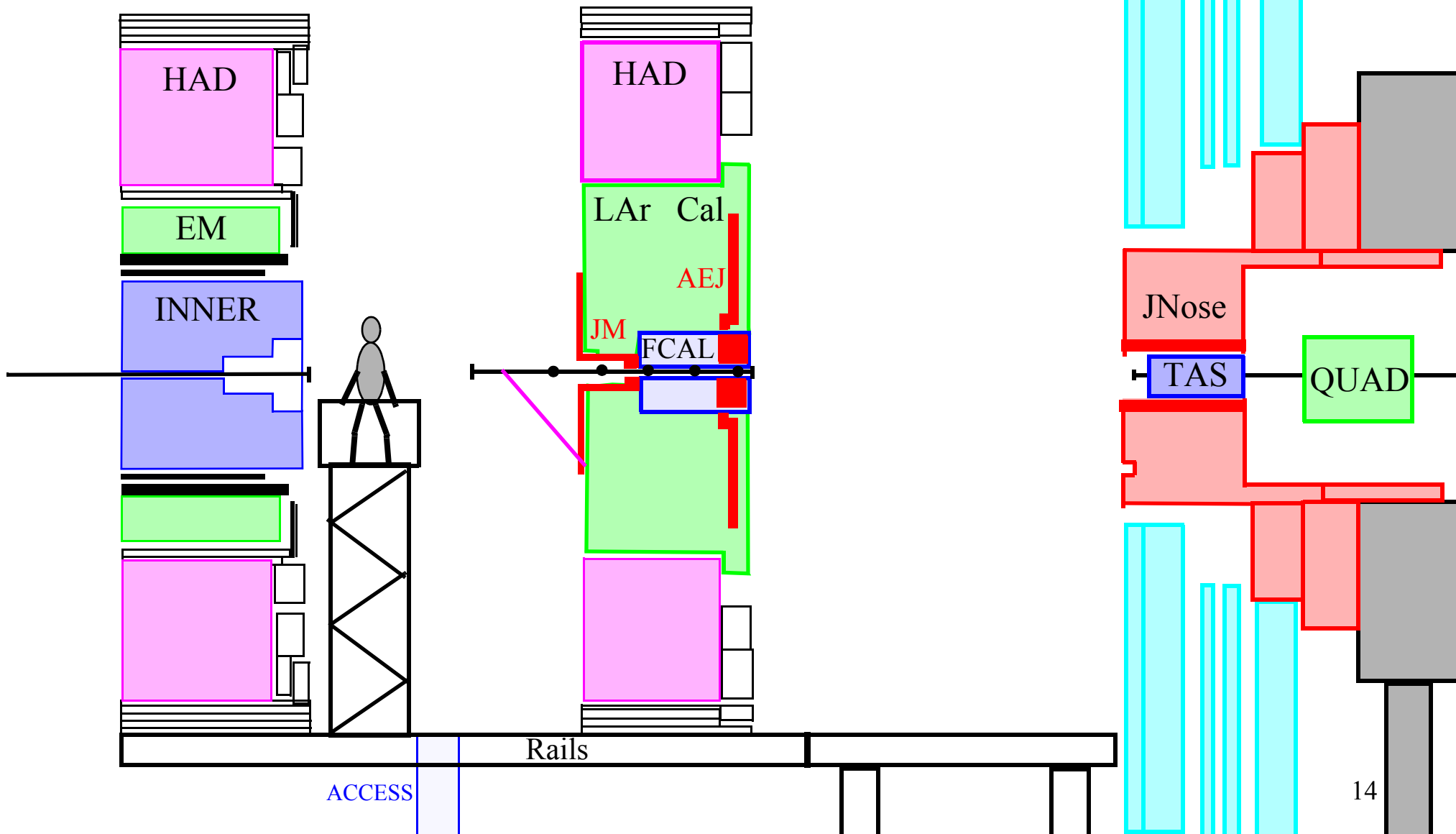

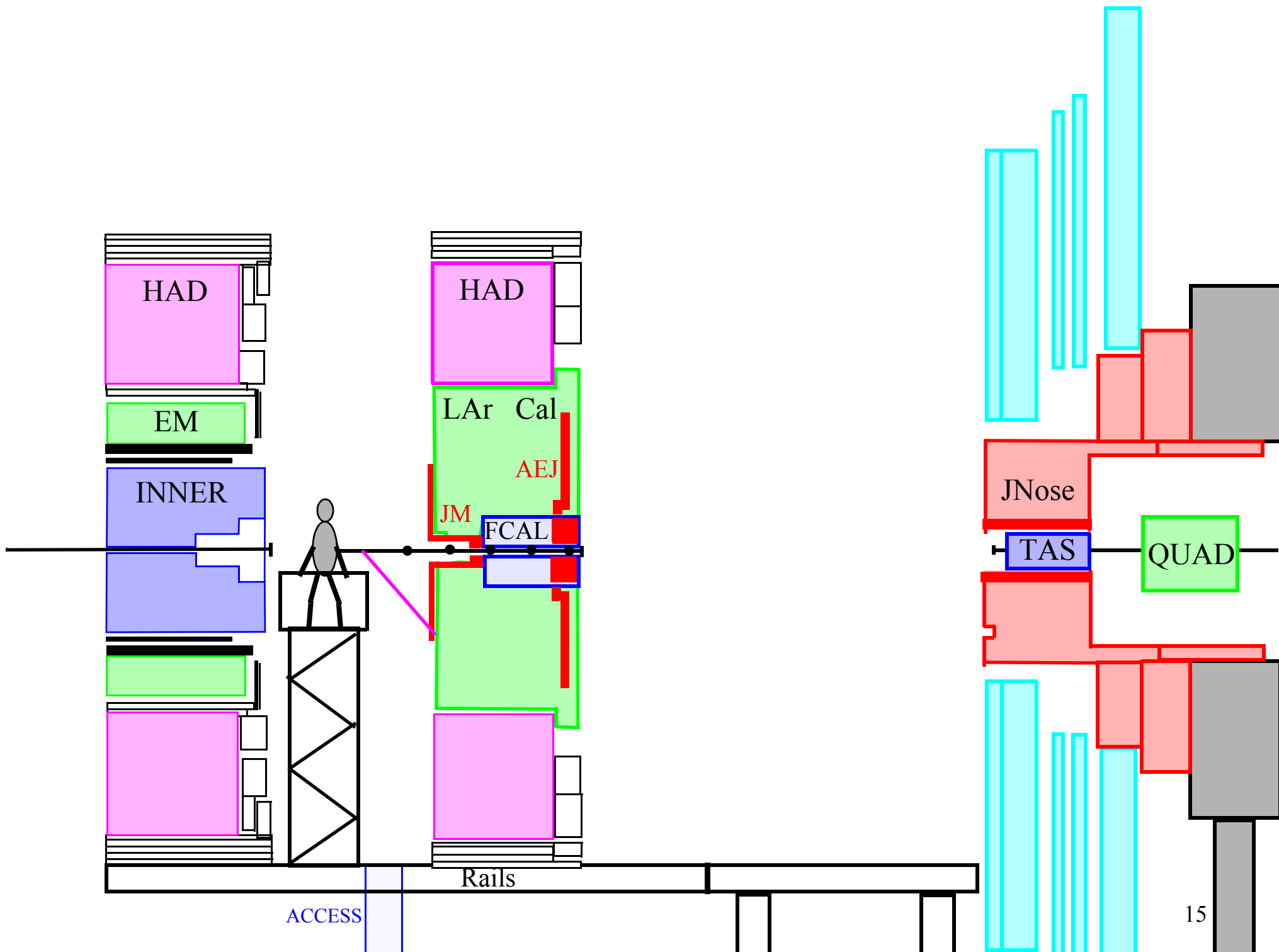

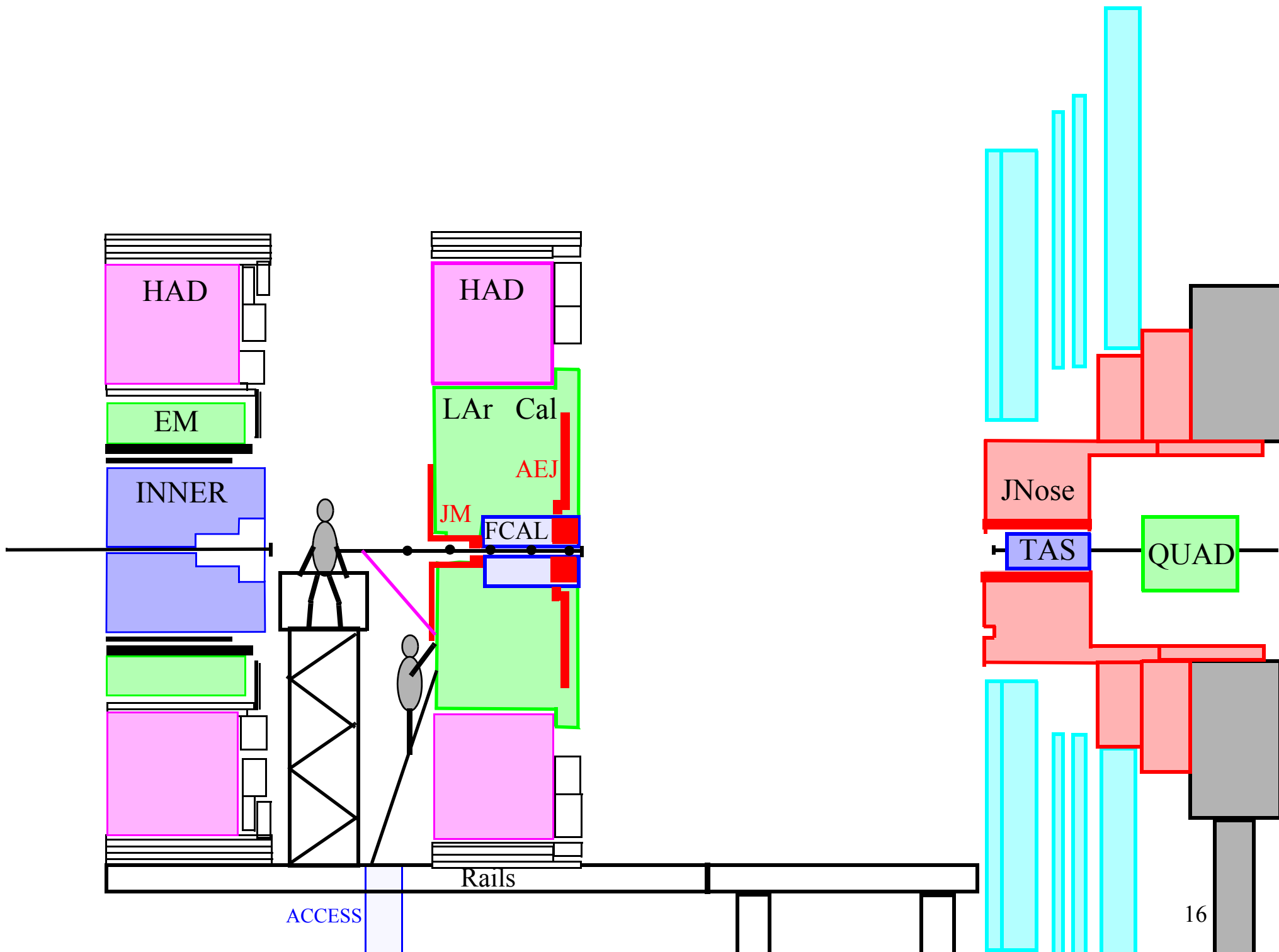

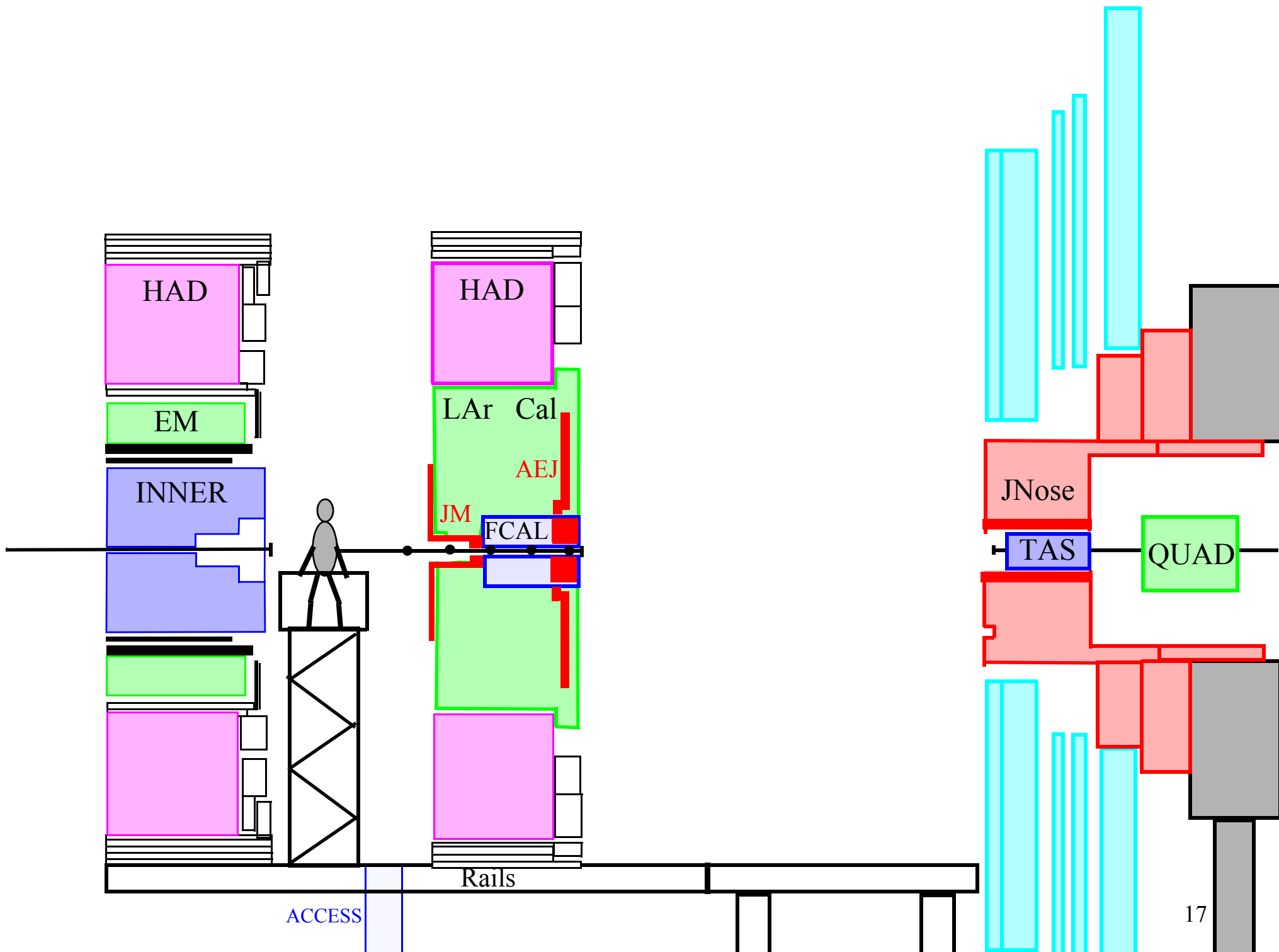

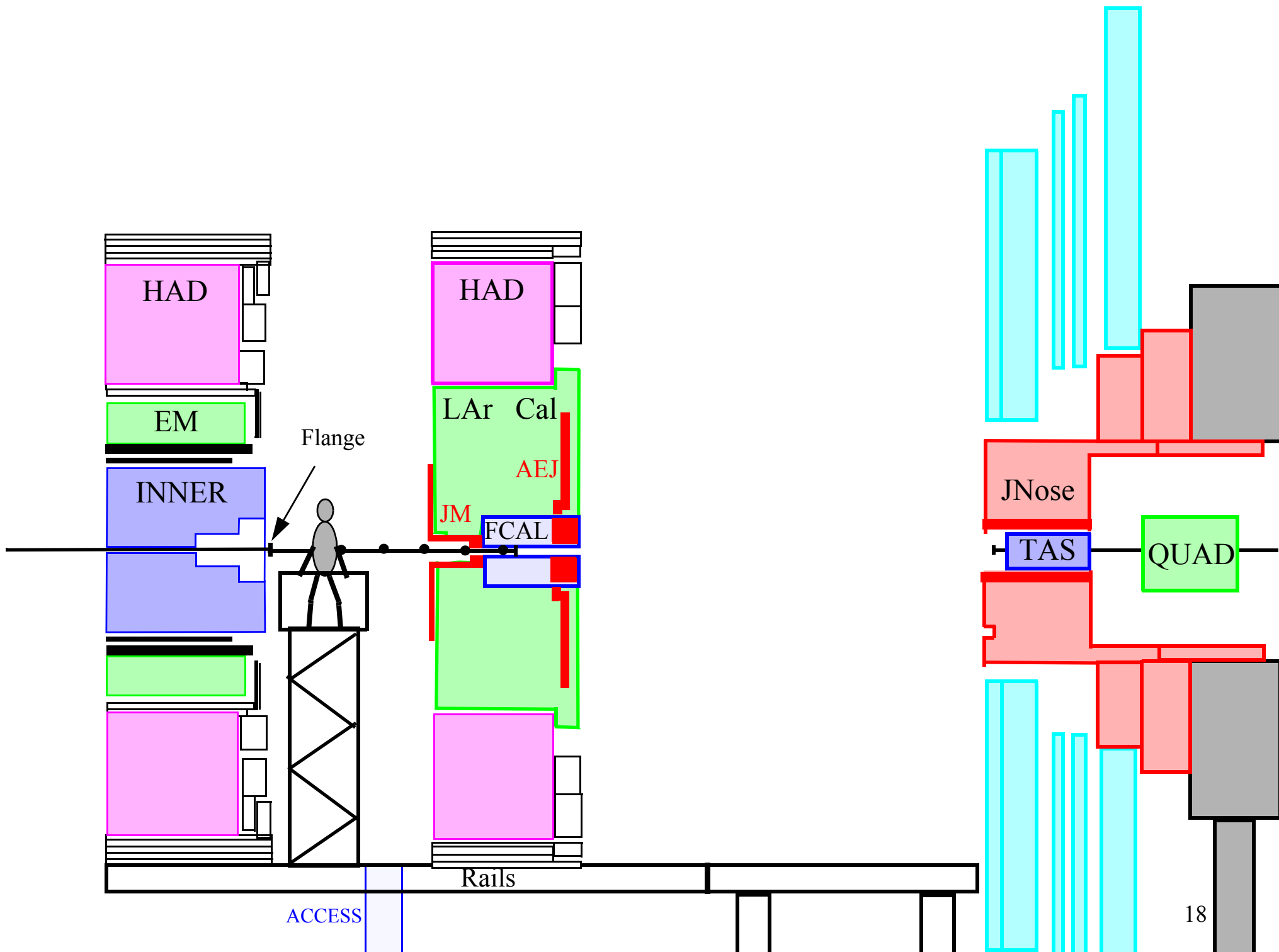

HAD

EM

INNER

Flange

ACCESS

HAD

LAr Cal

AEJ

JM

FCAL

Rails

JNose

TAS

QUAD

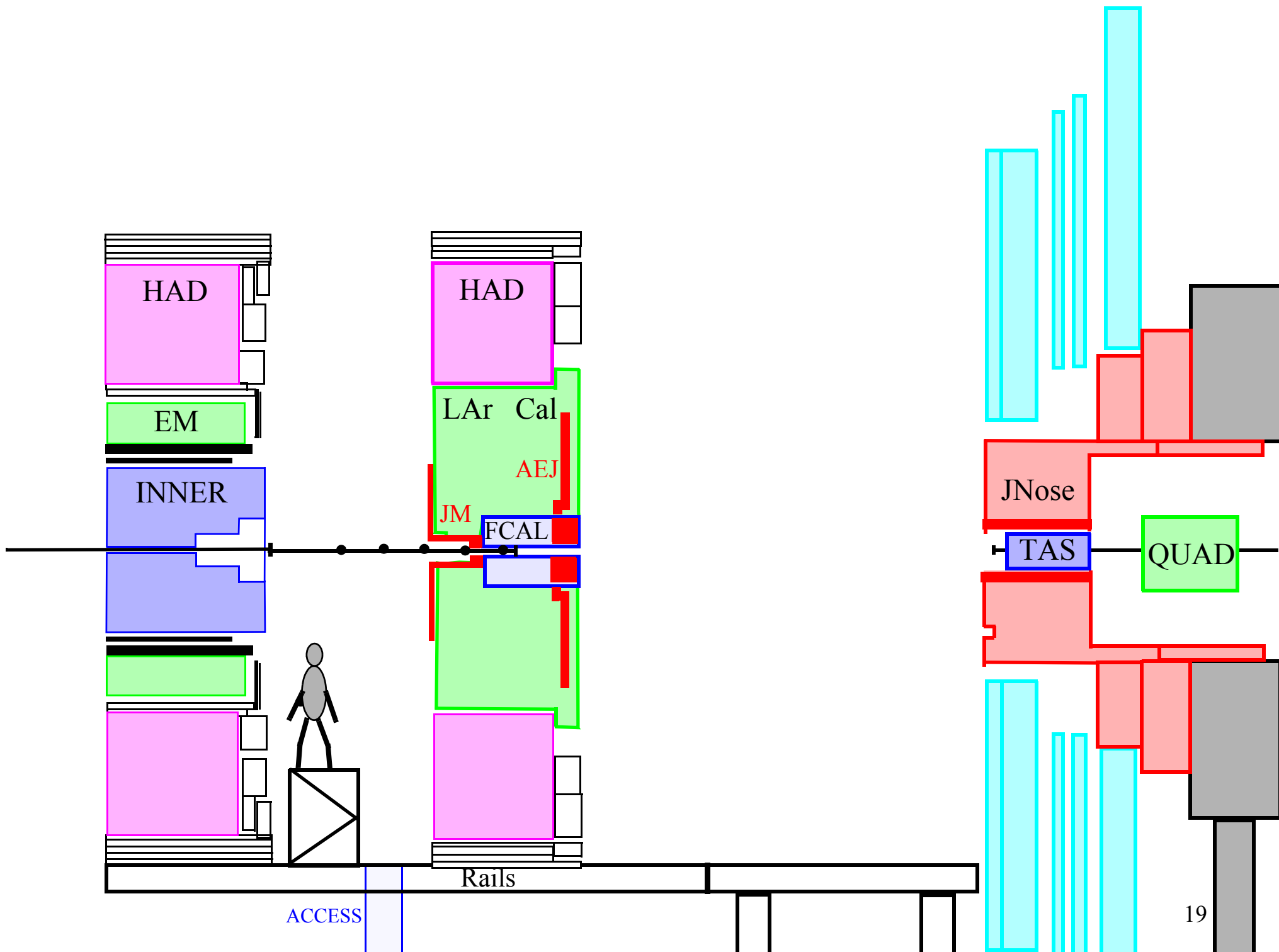

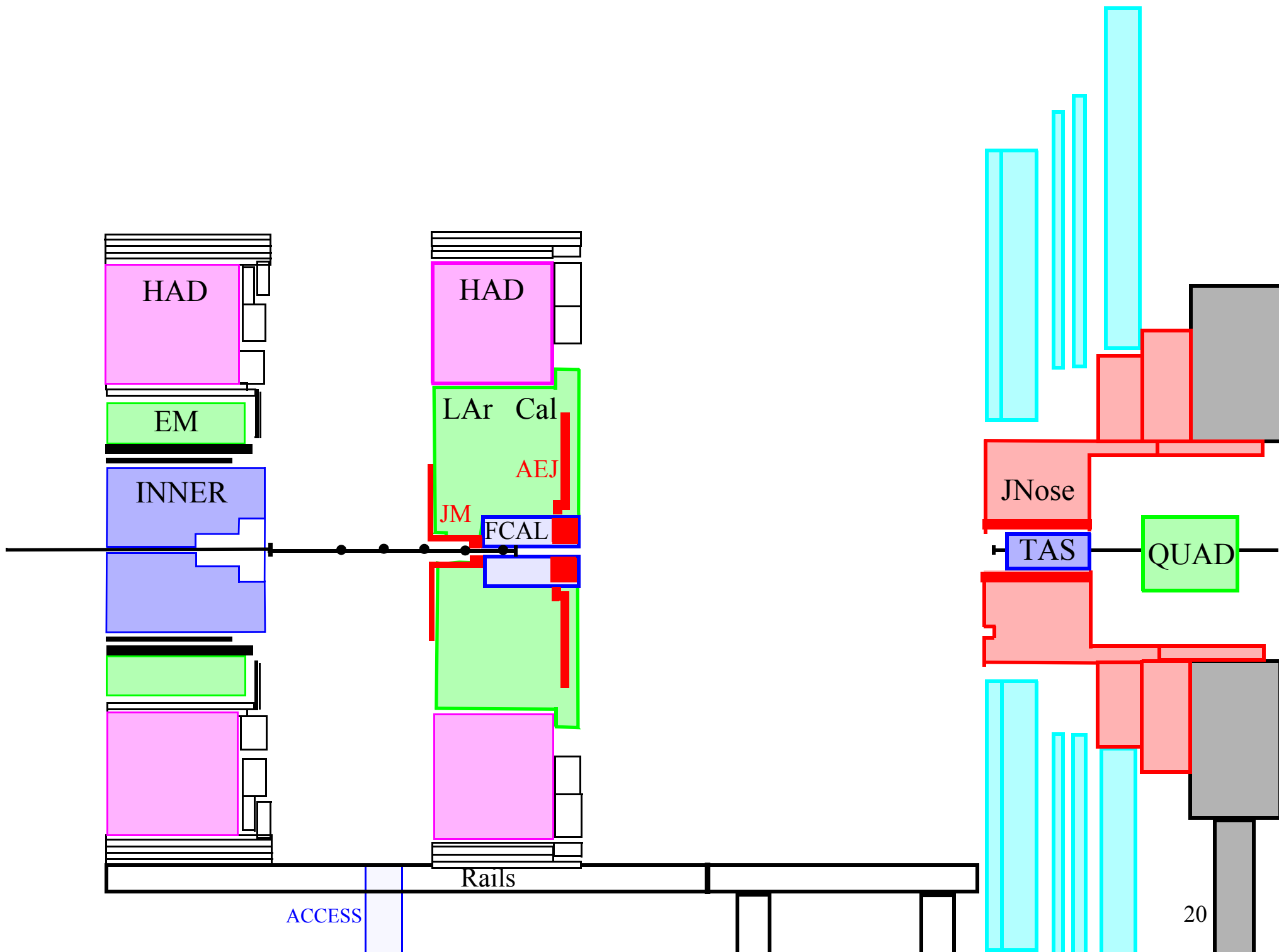

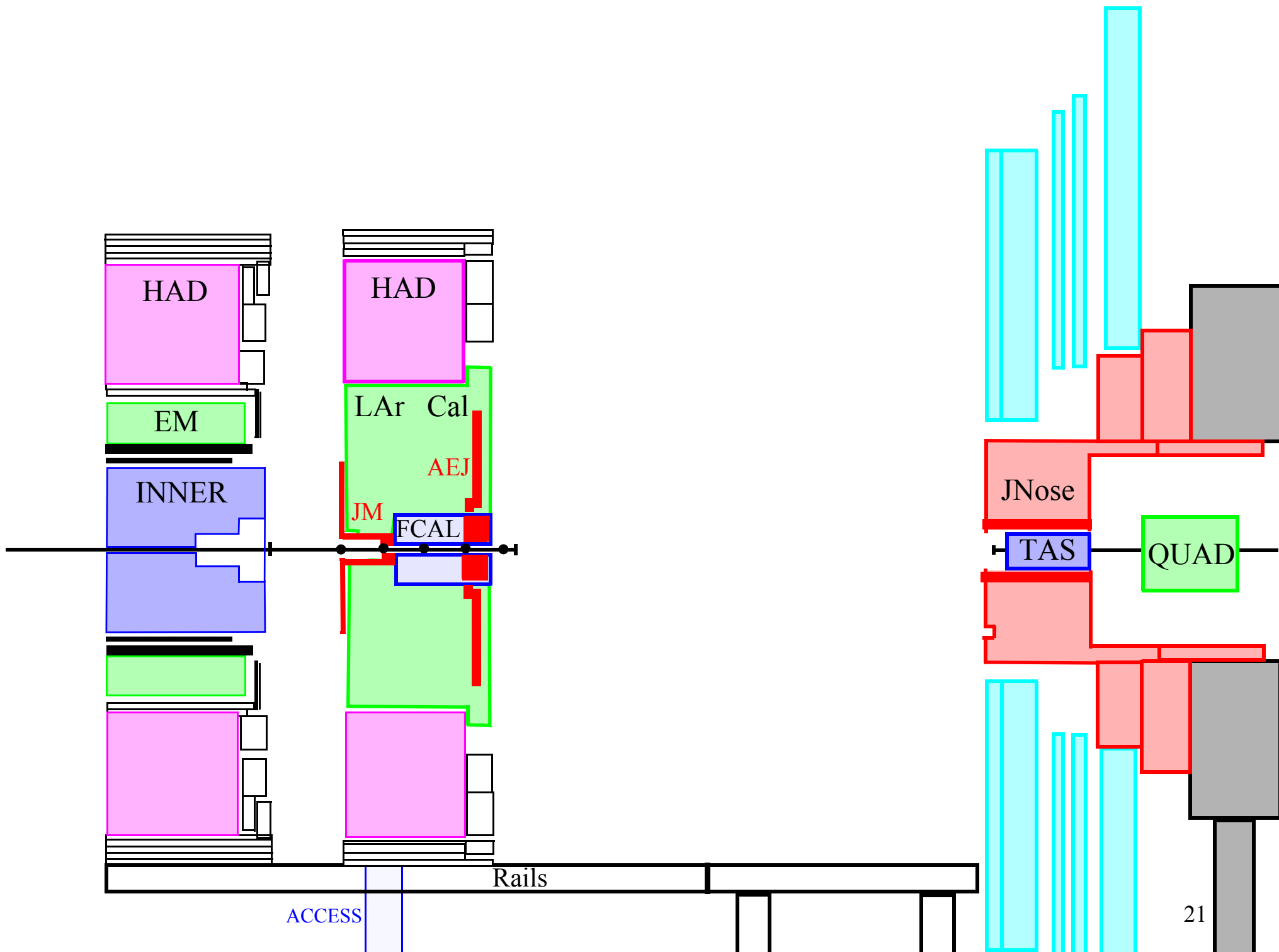

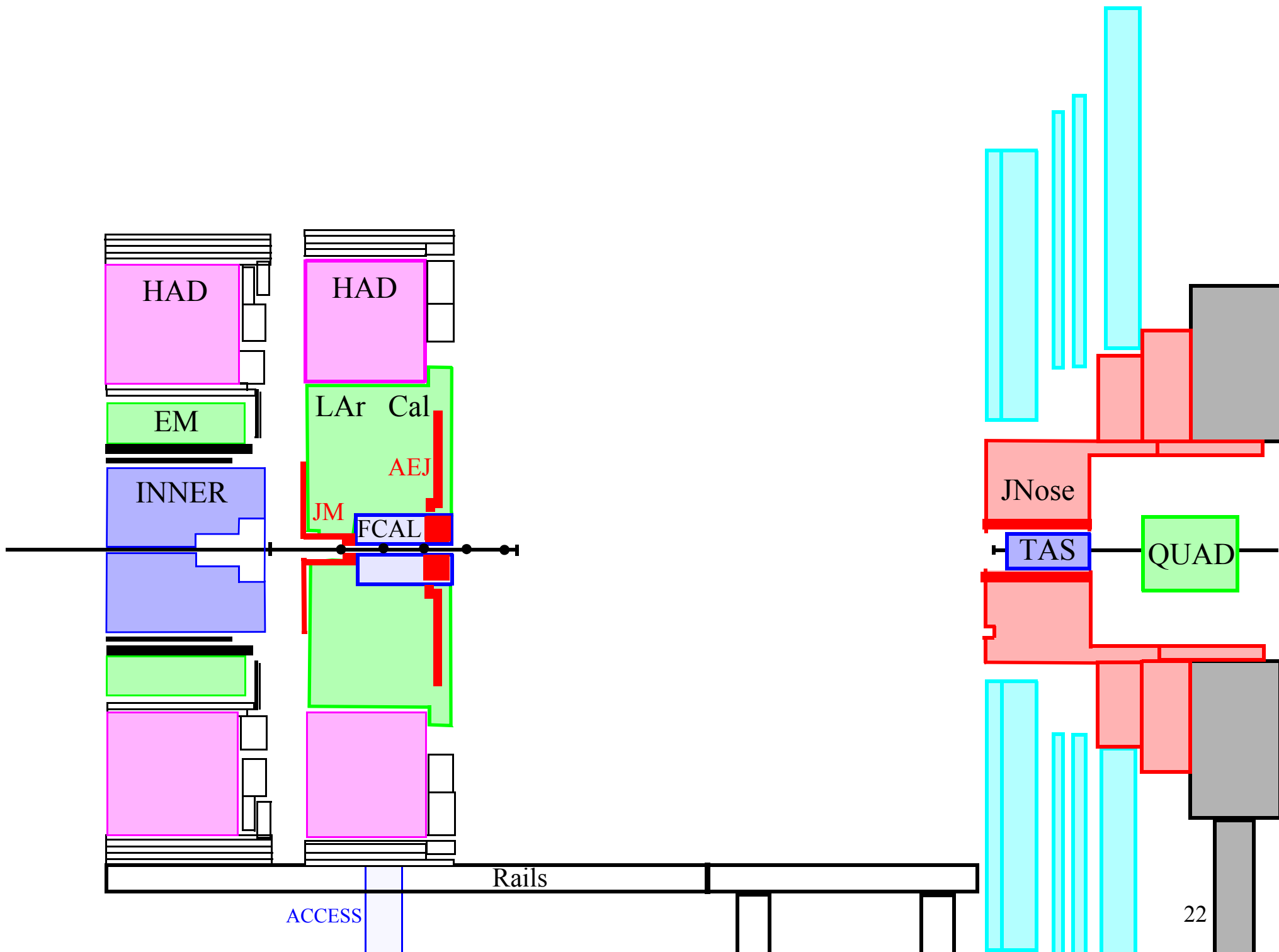

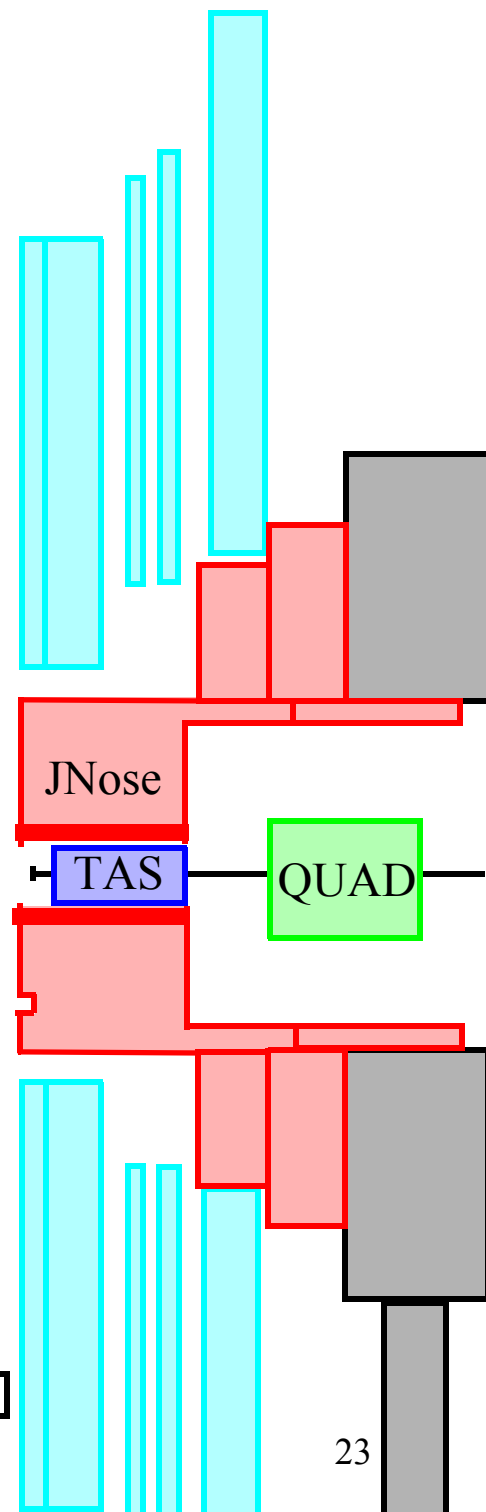
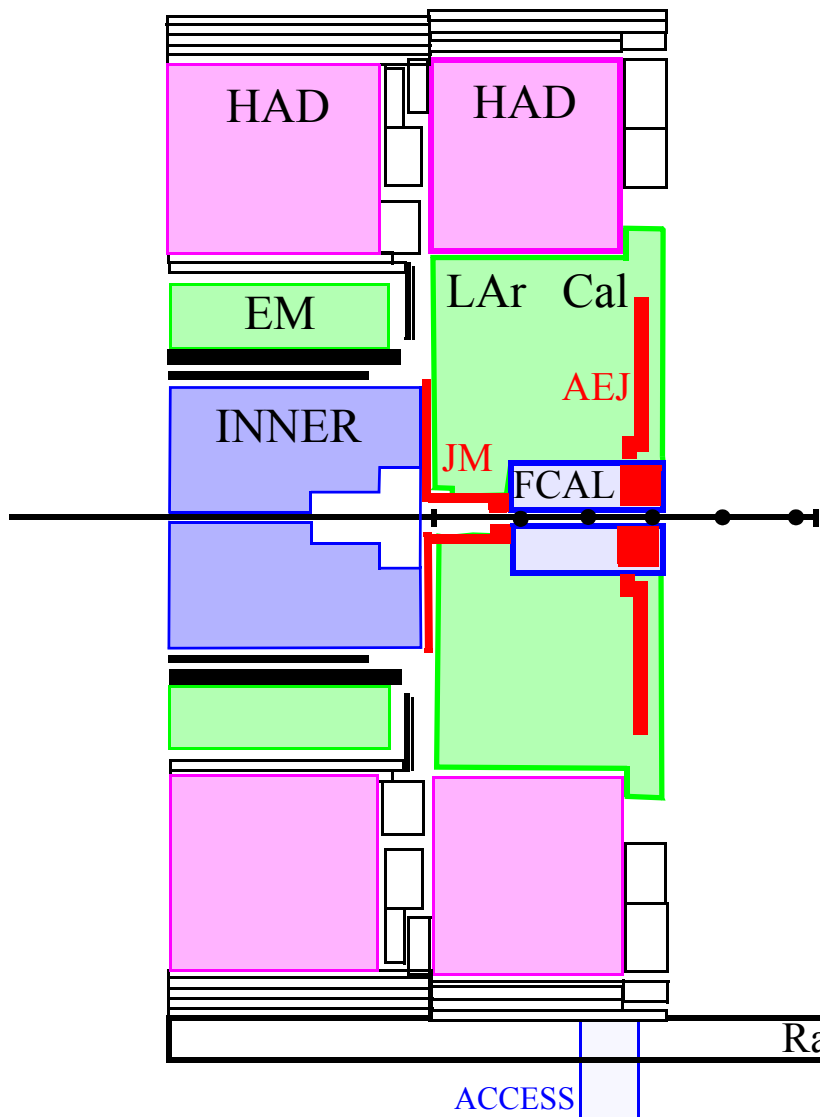

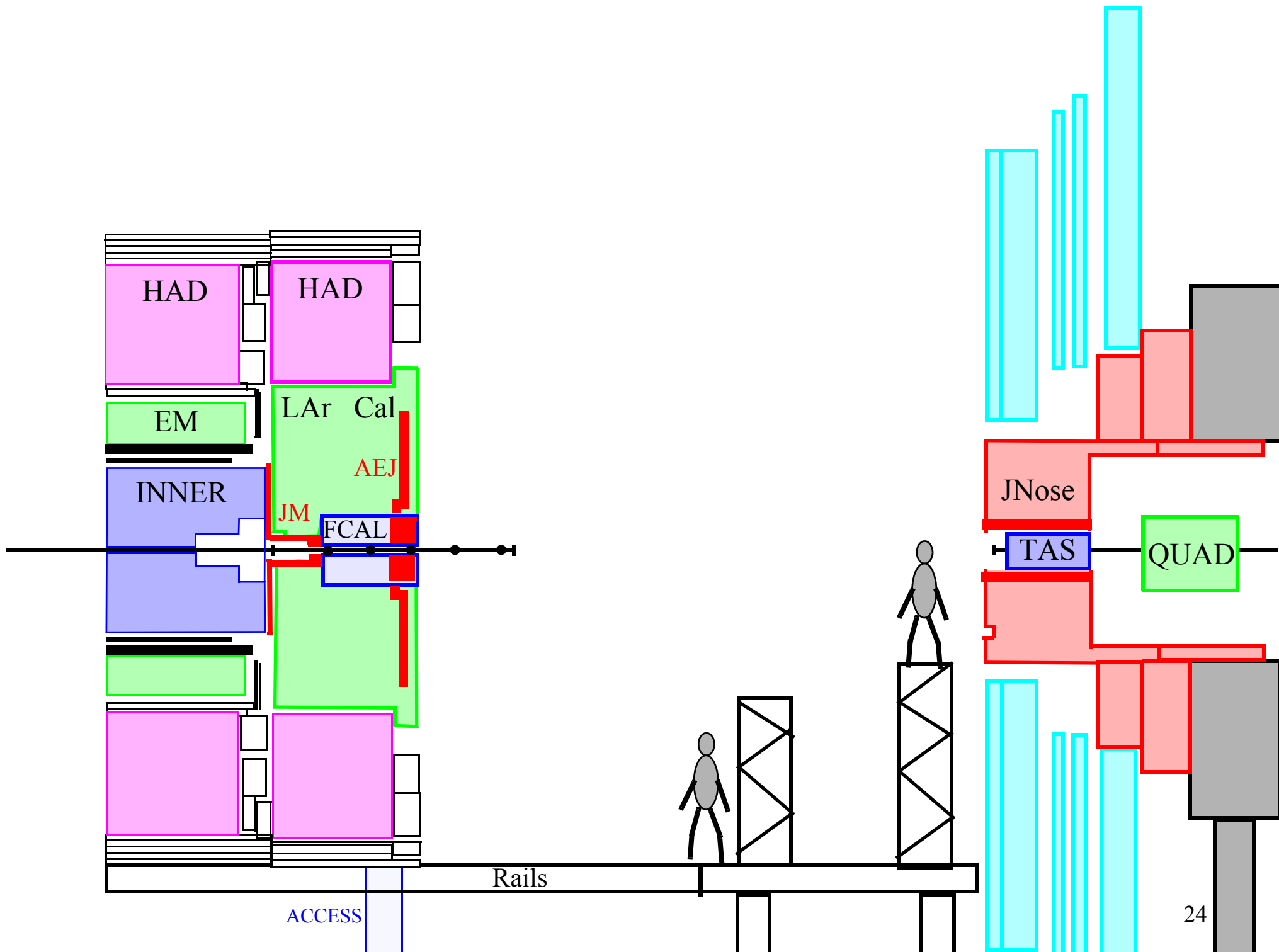

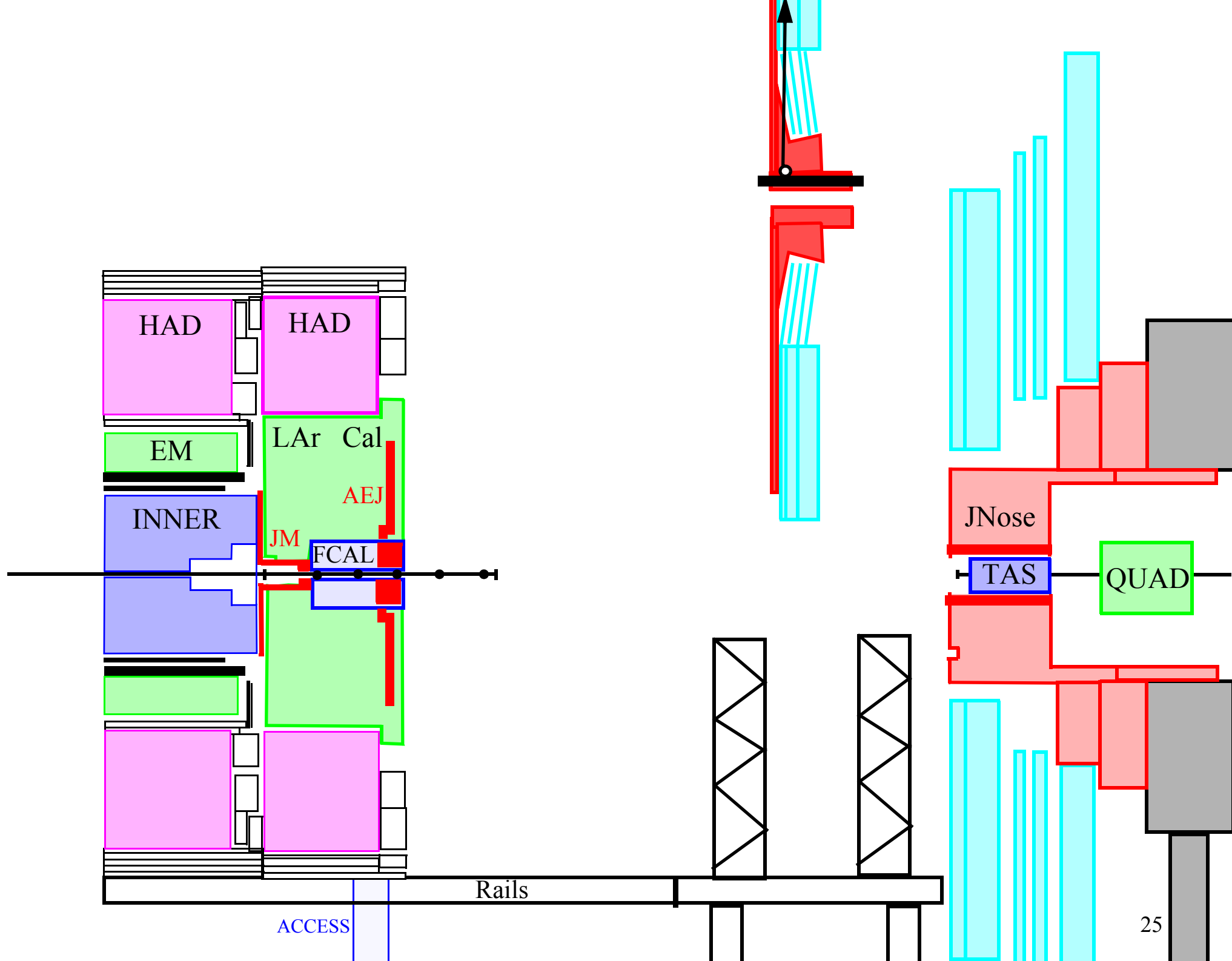

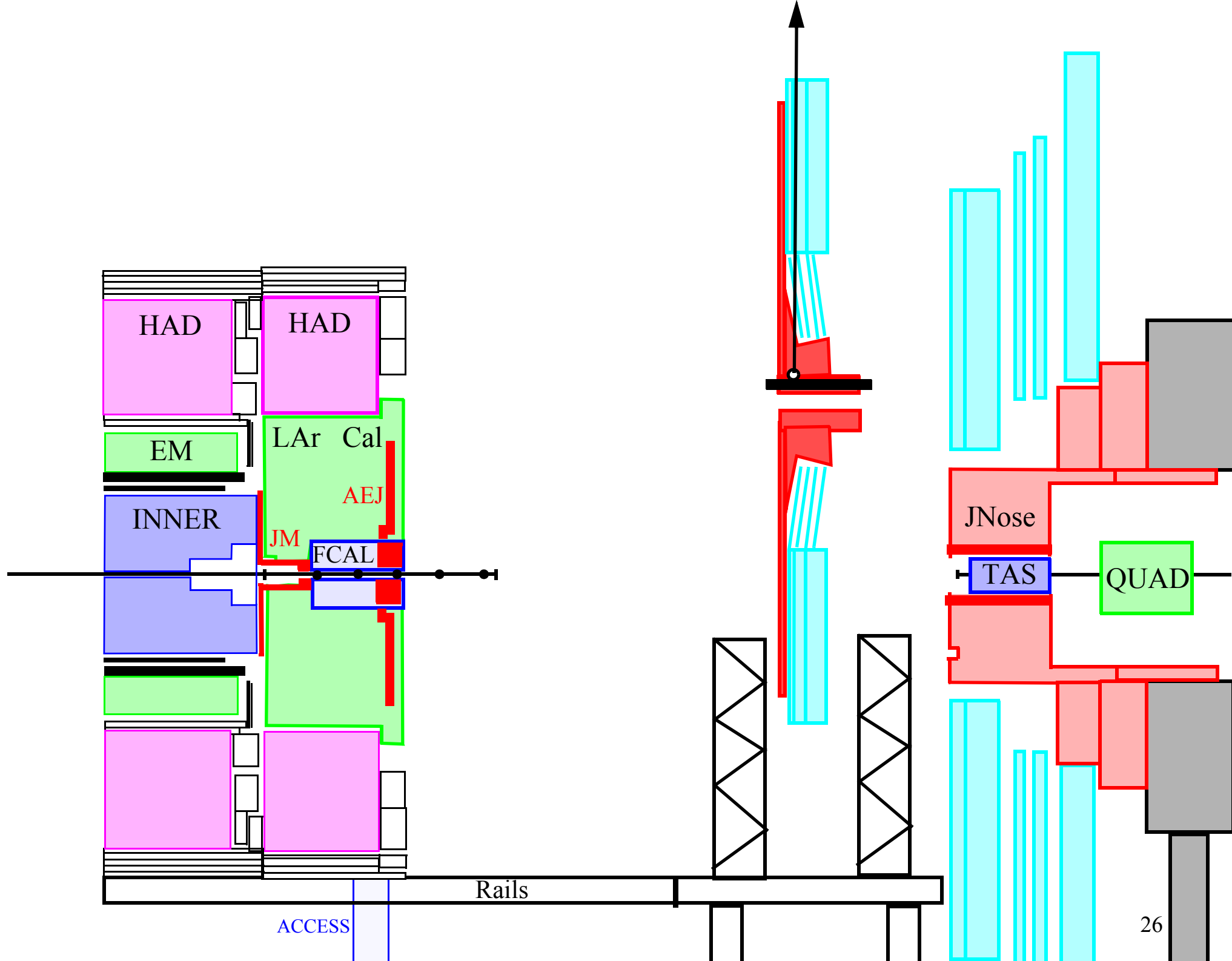

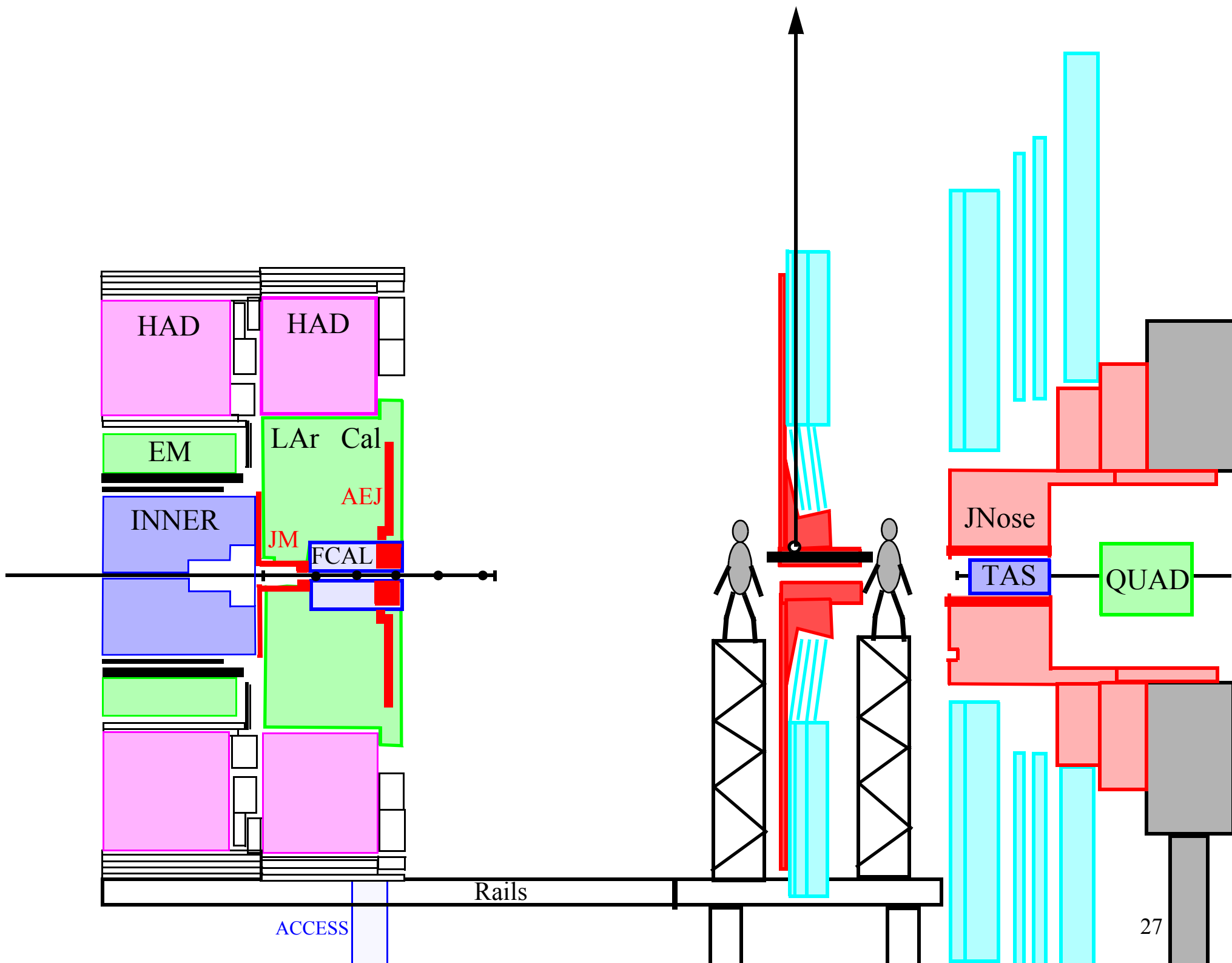

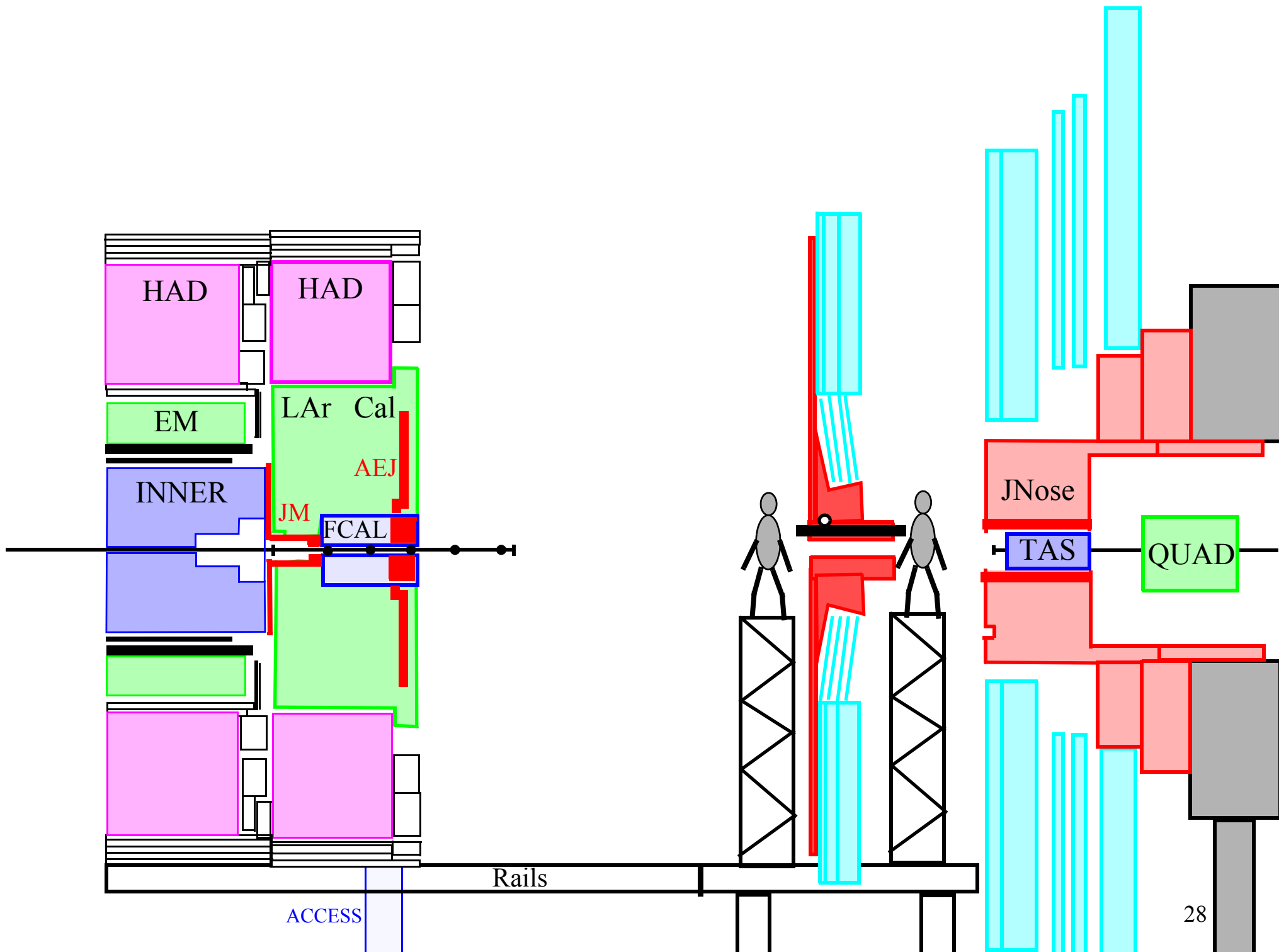

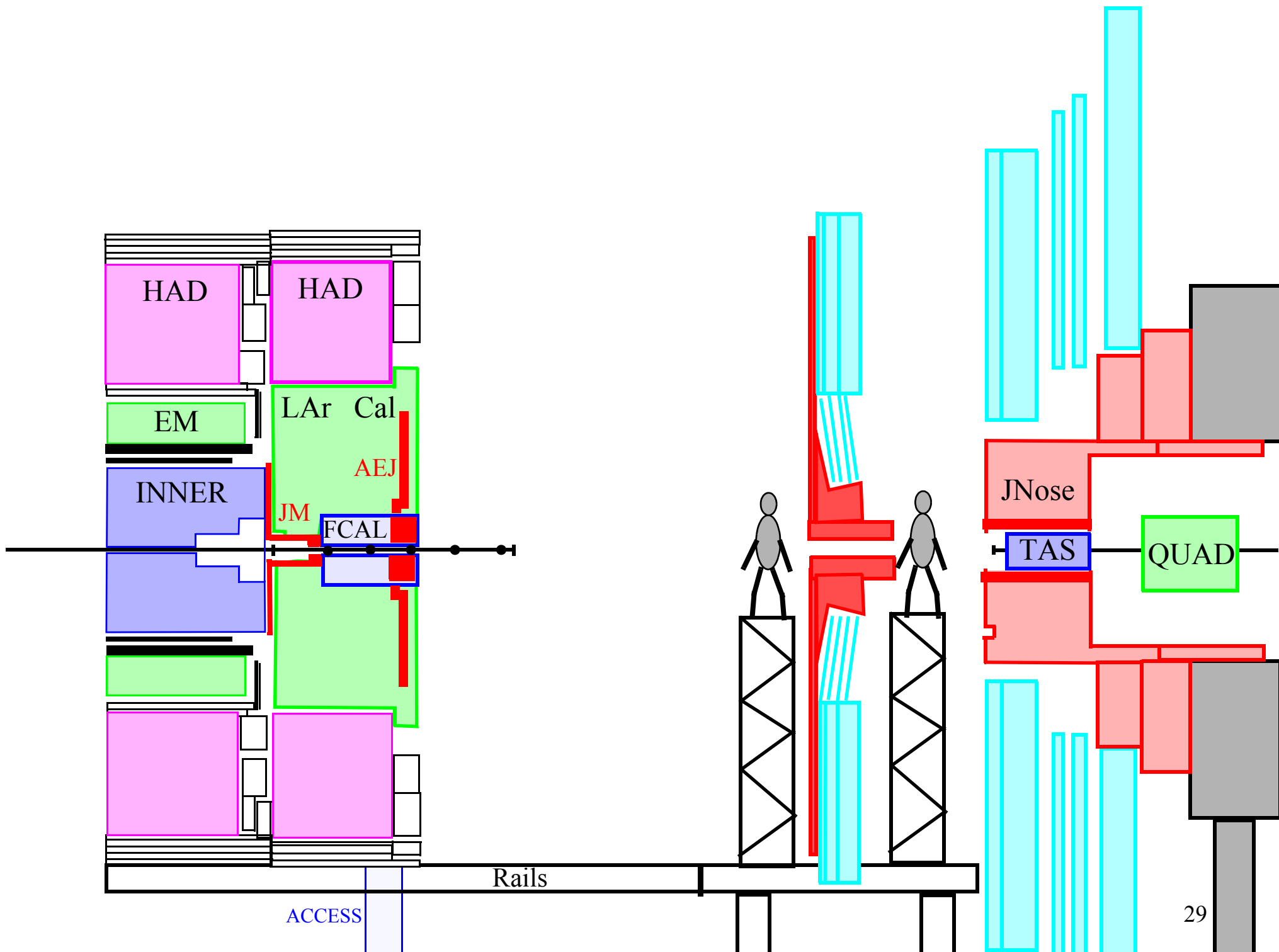

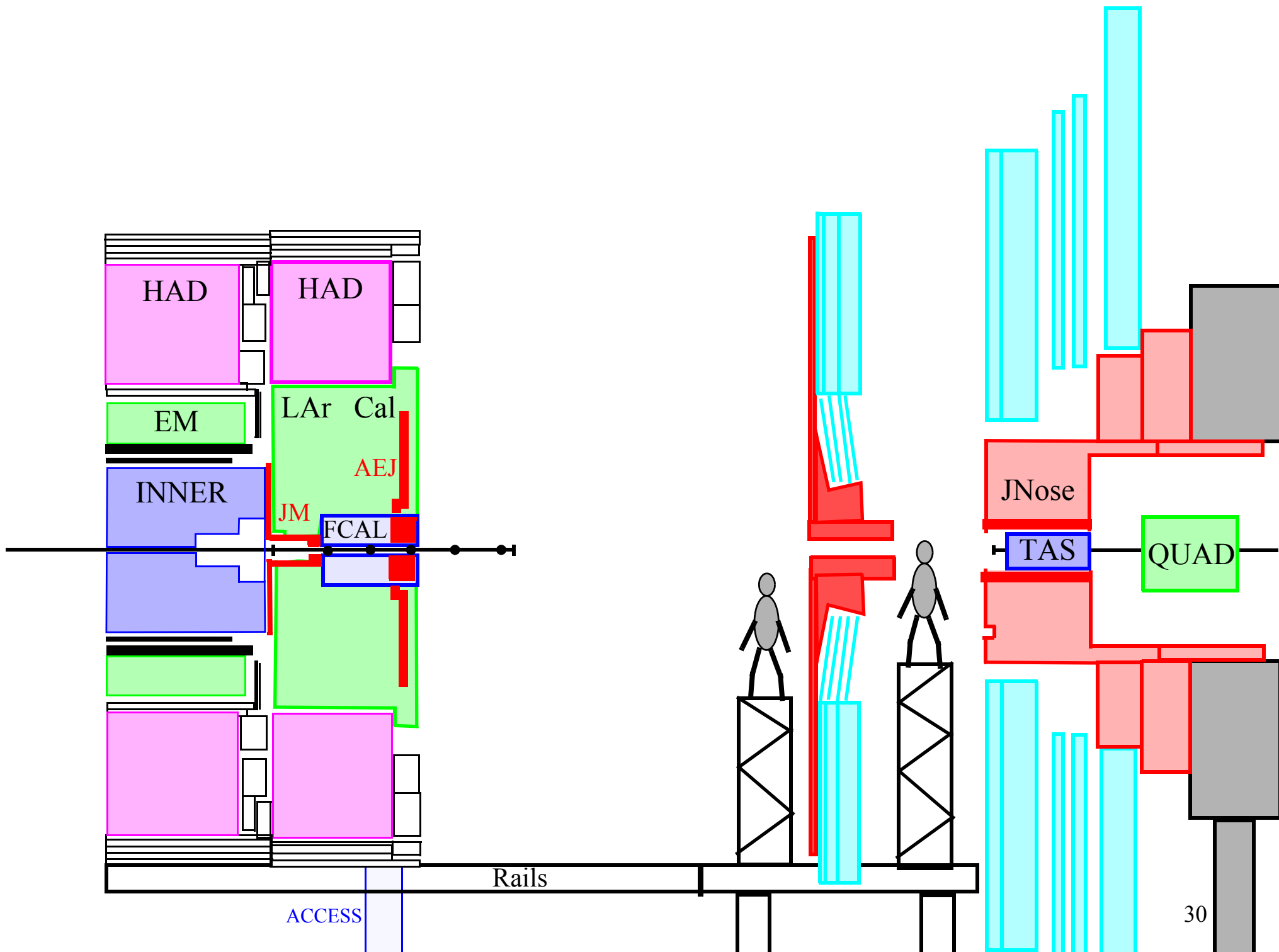

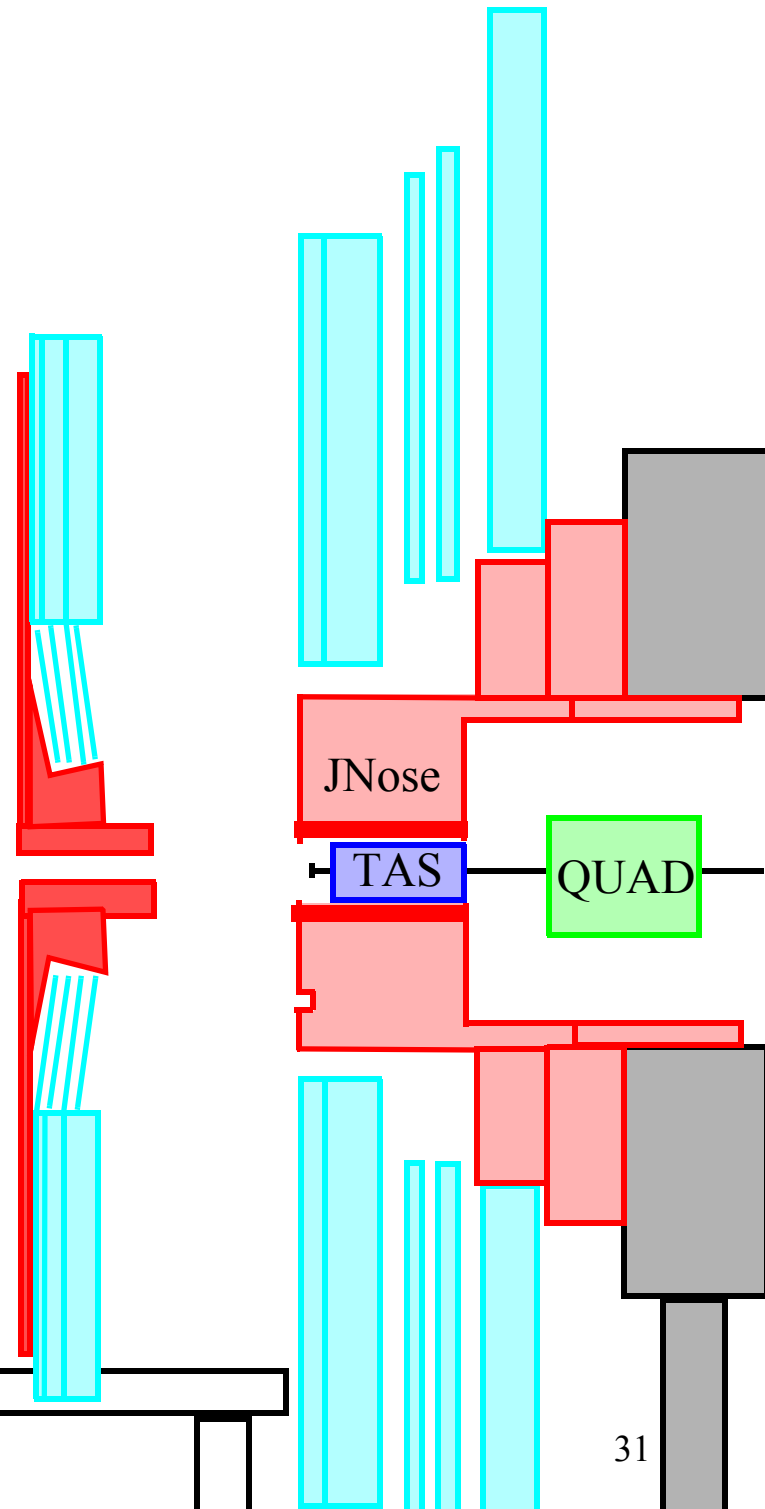
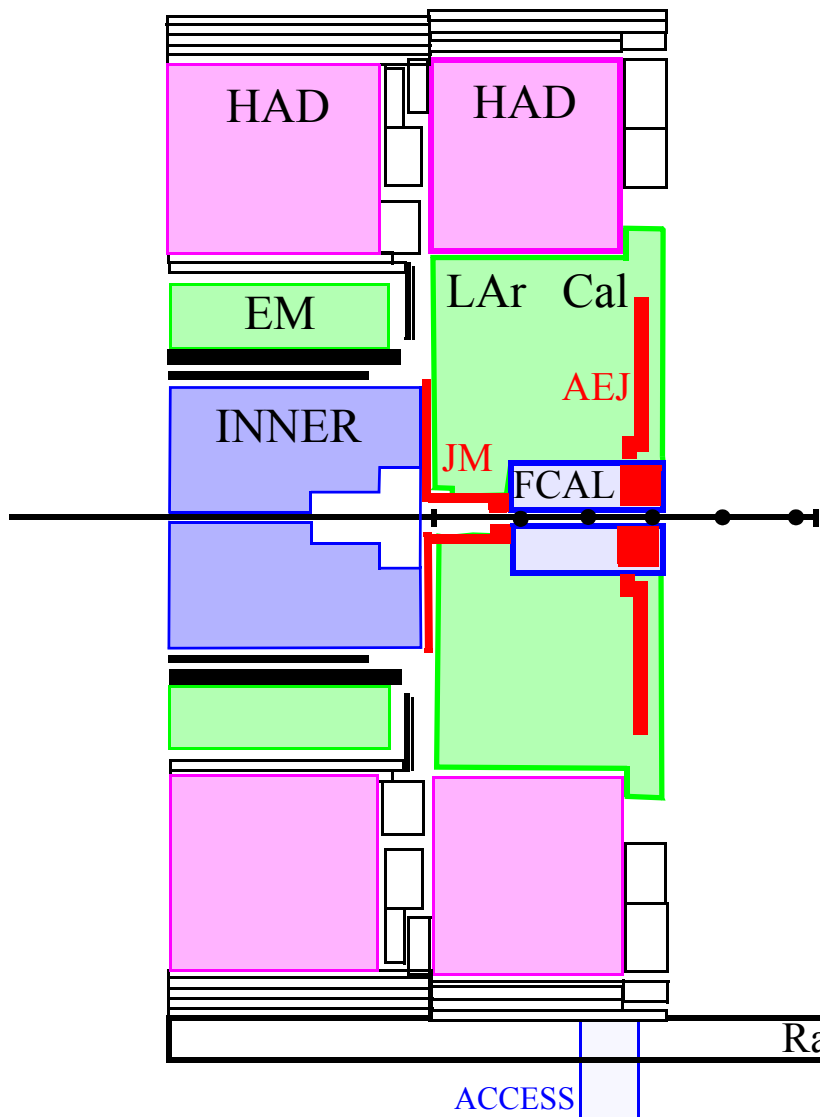

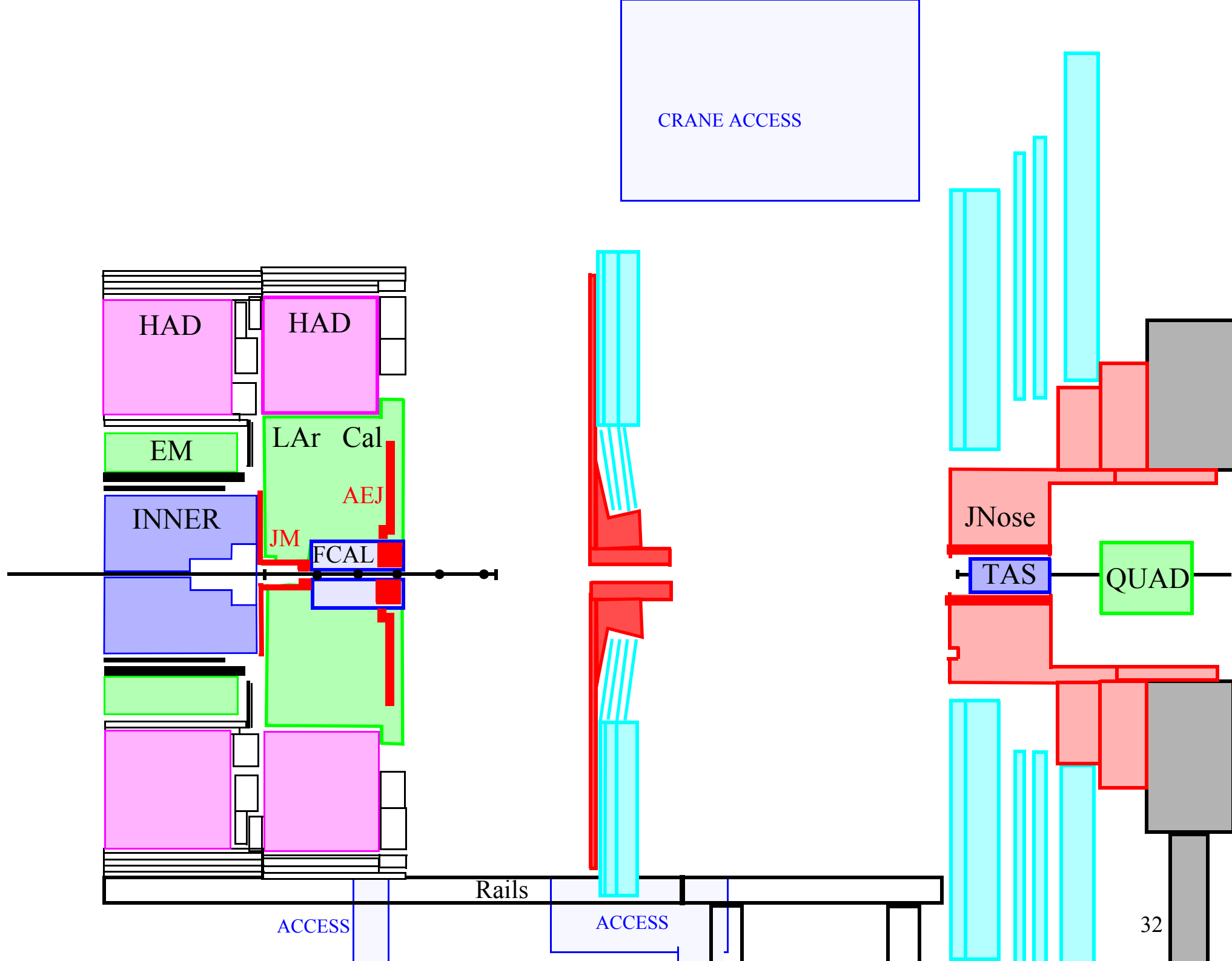

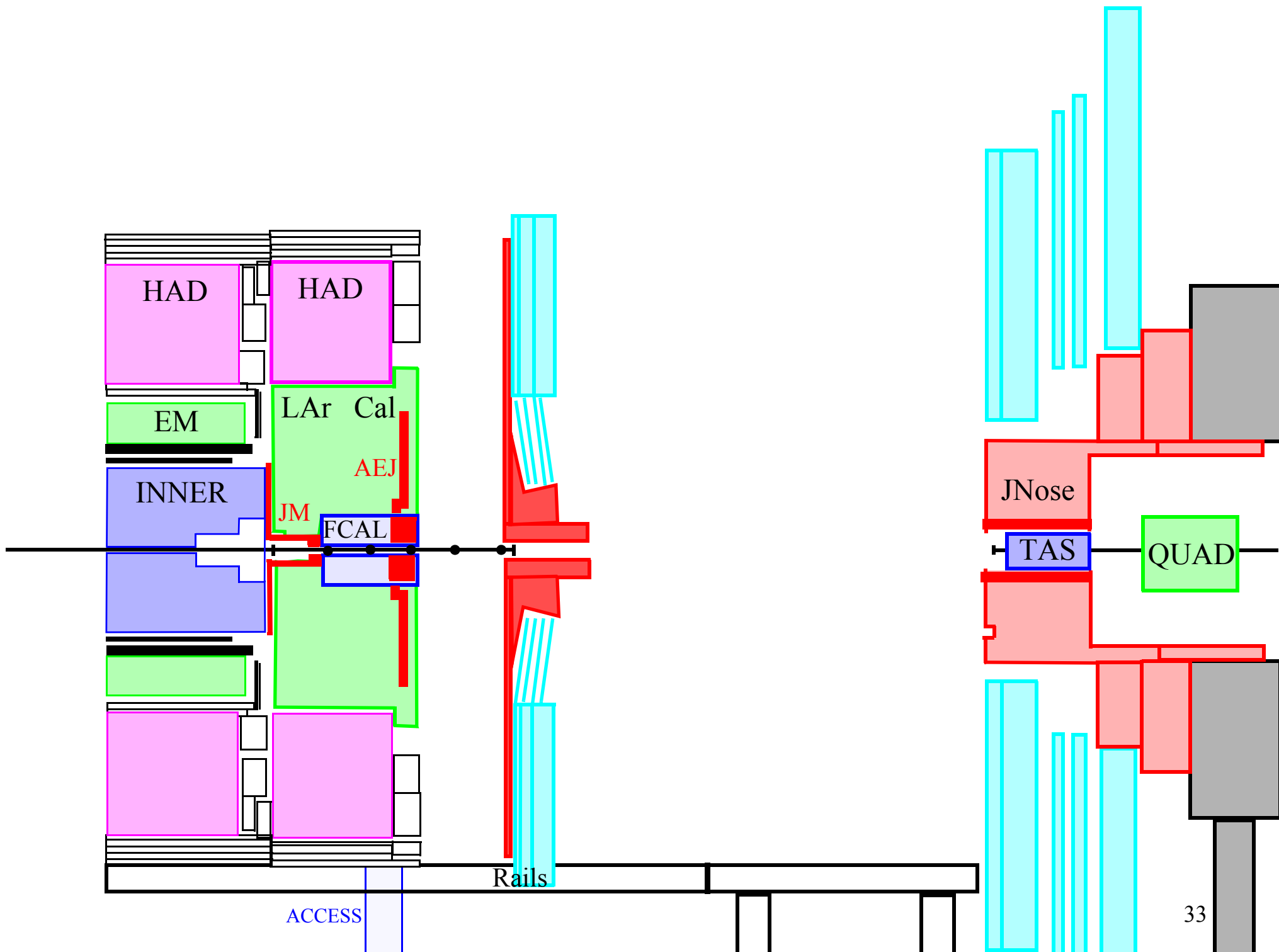

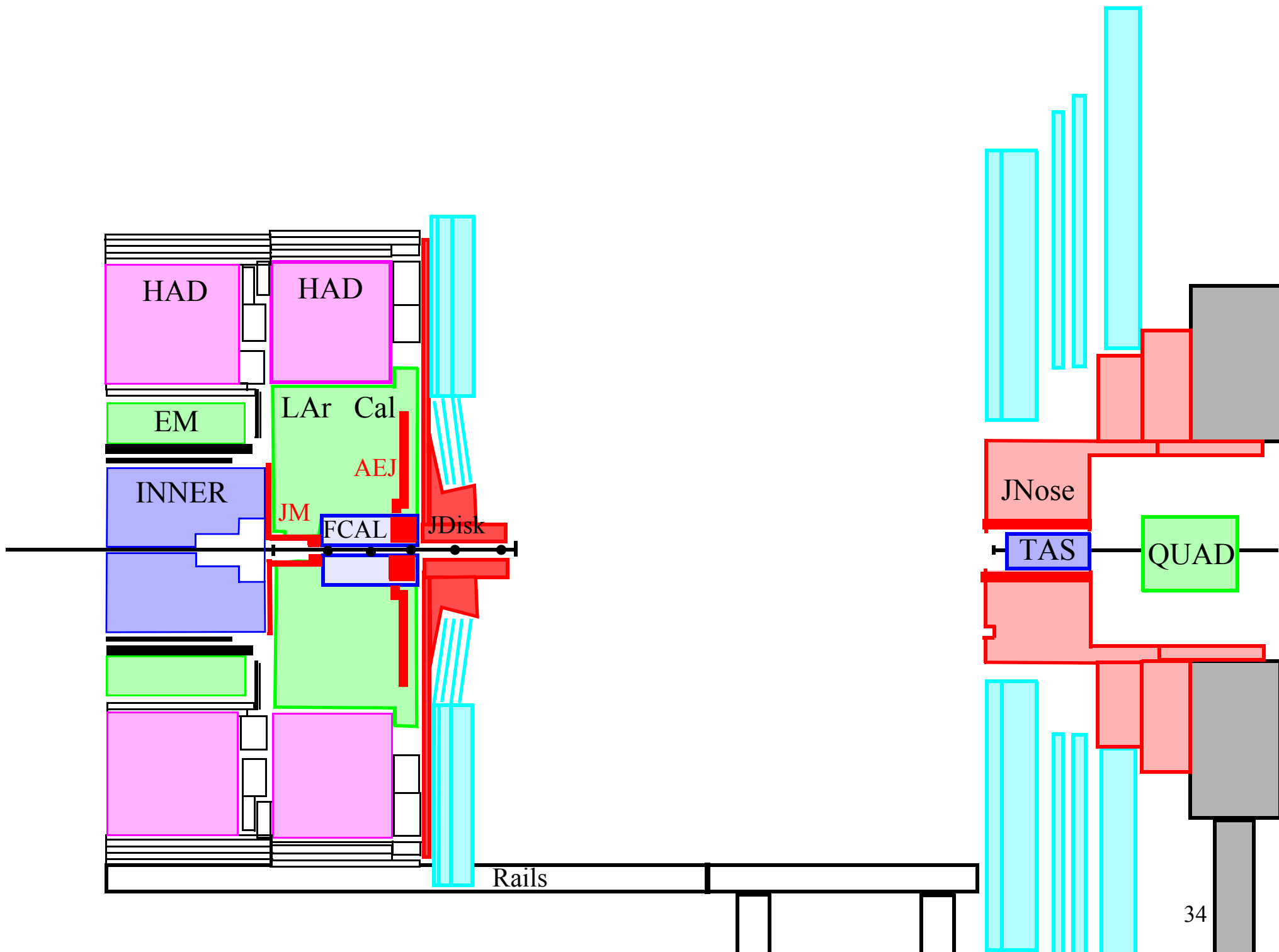

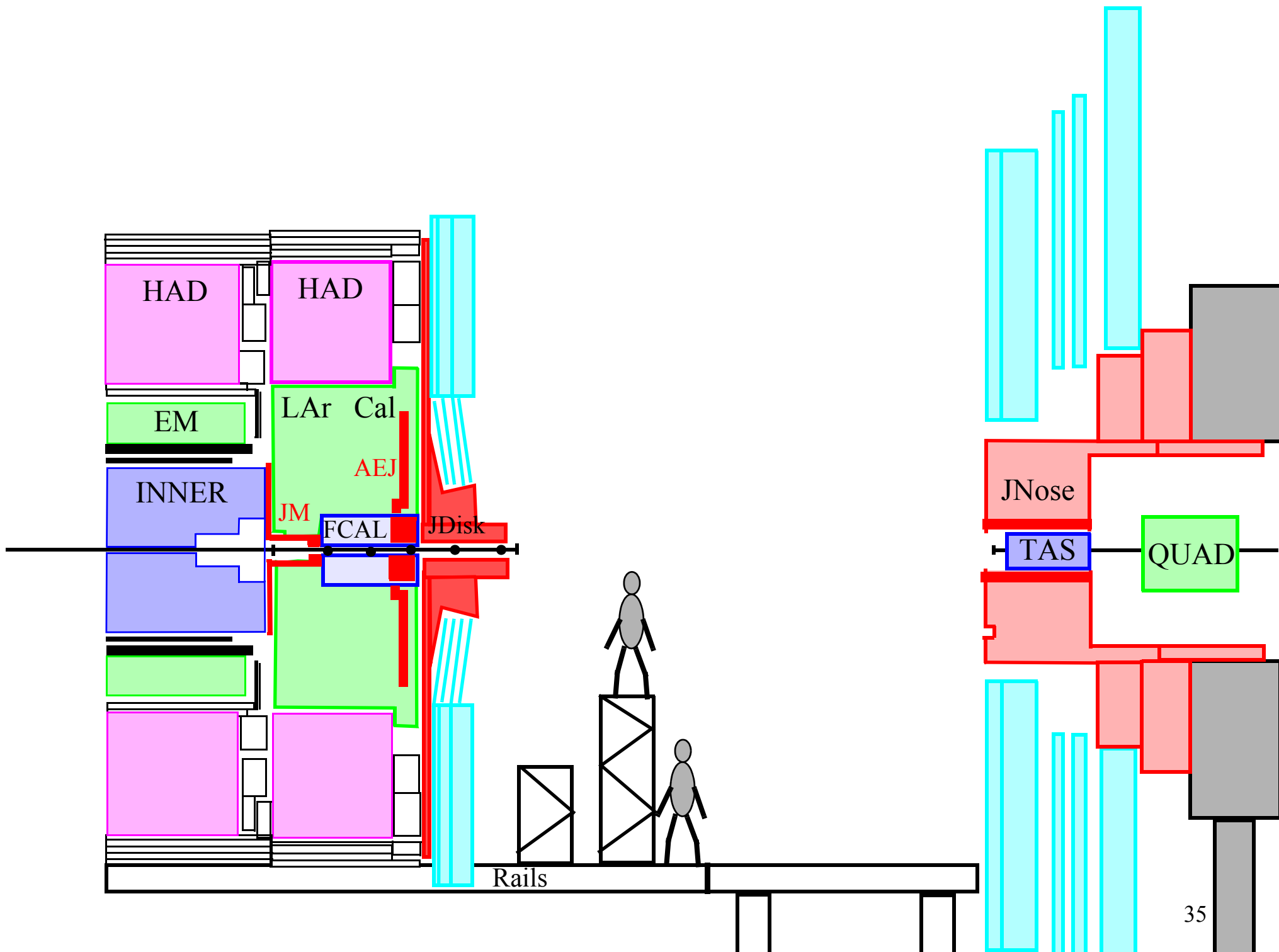

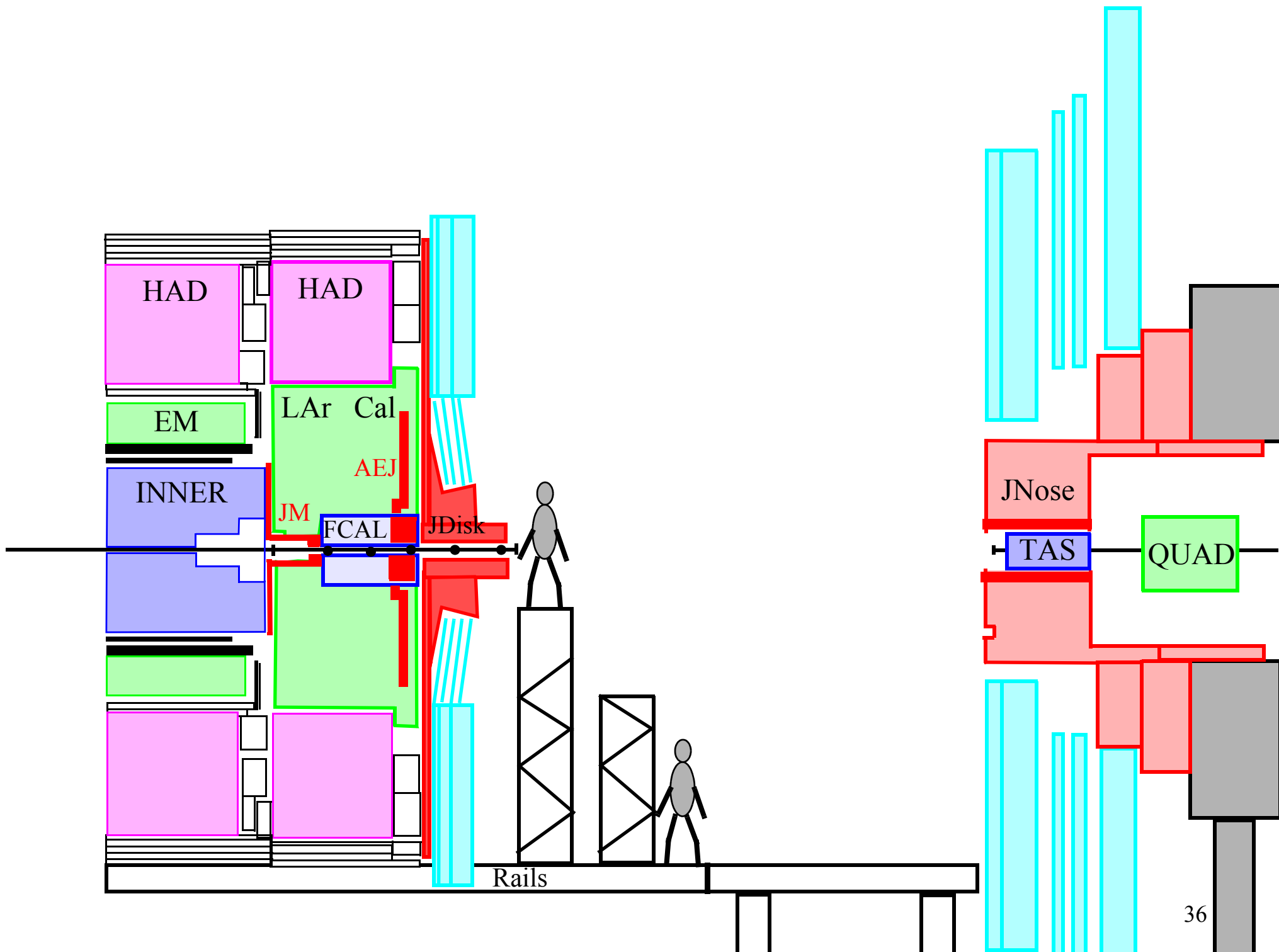

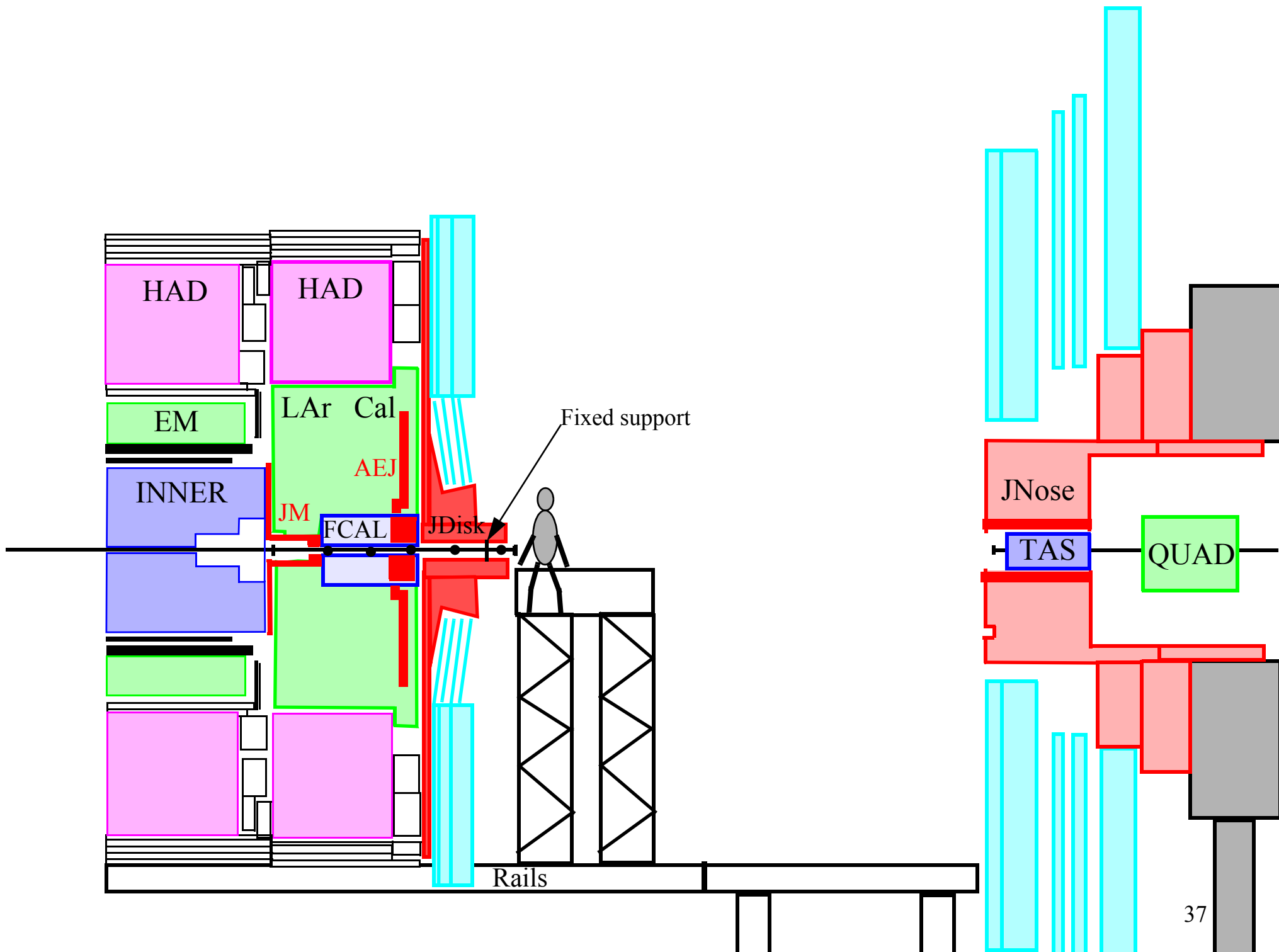

Beampipe supports

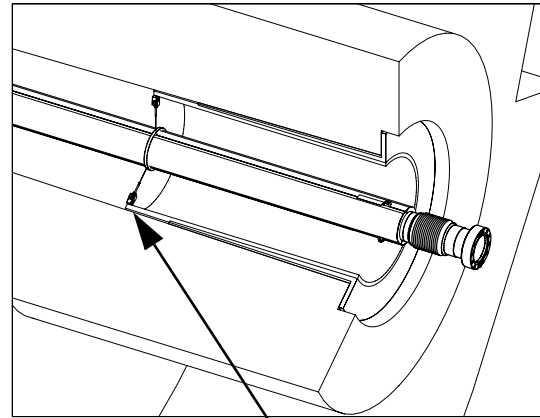
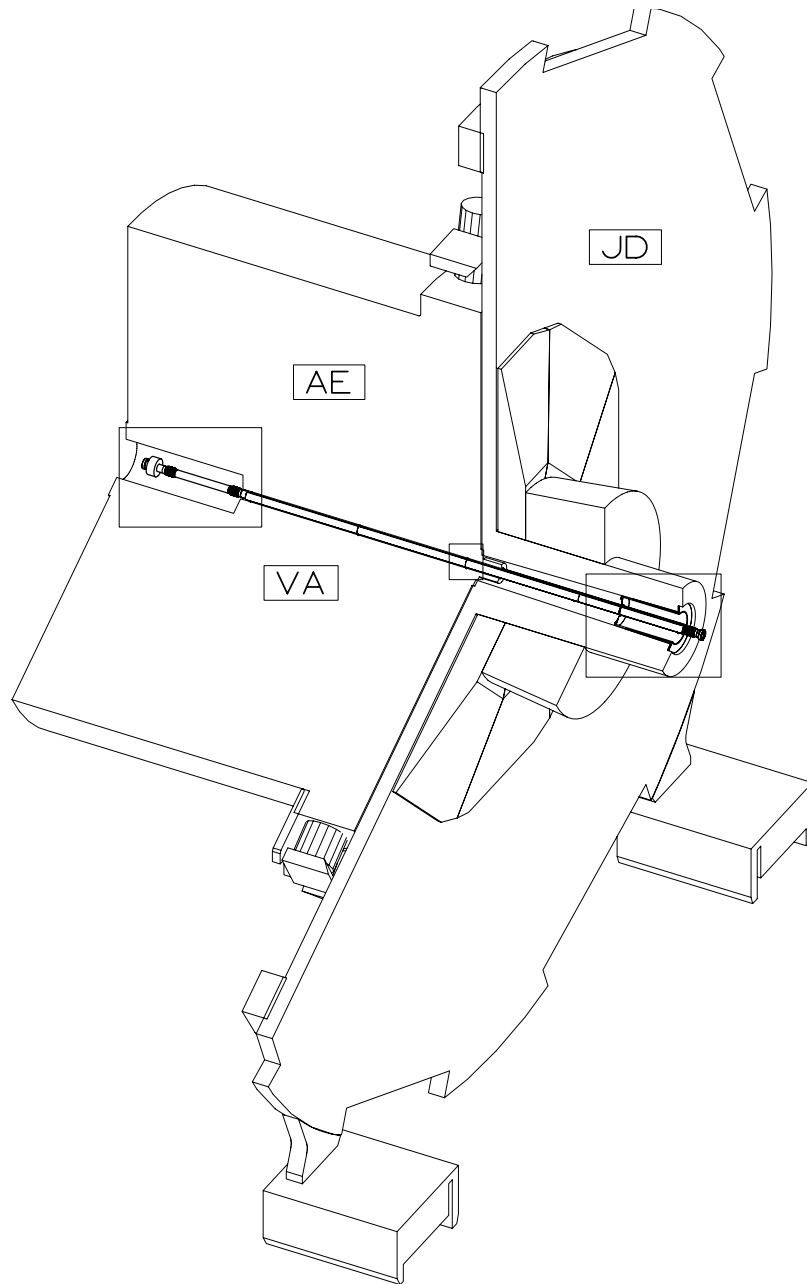

This support has to be attached.

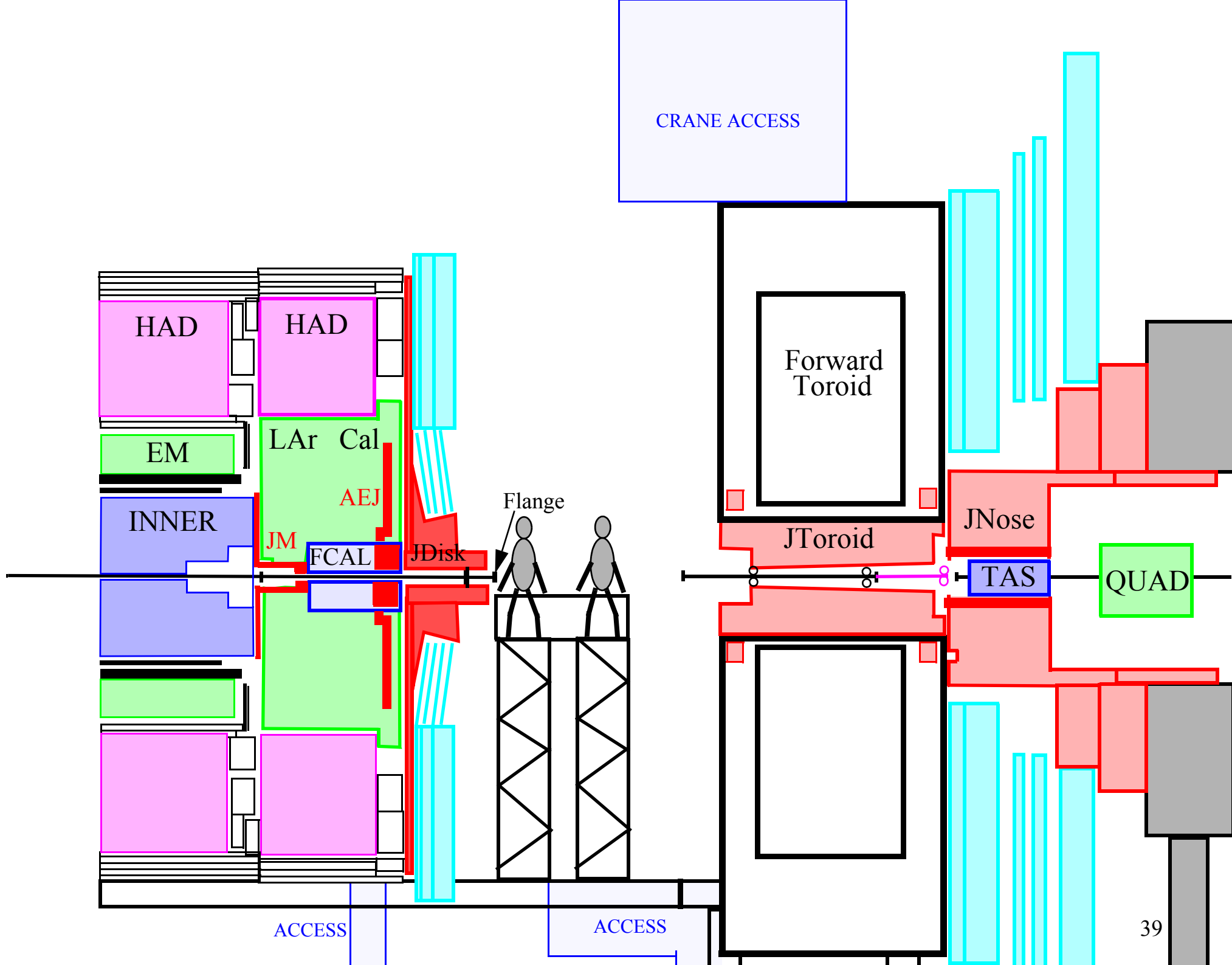

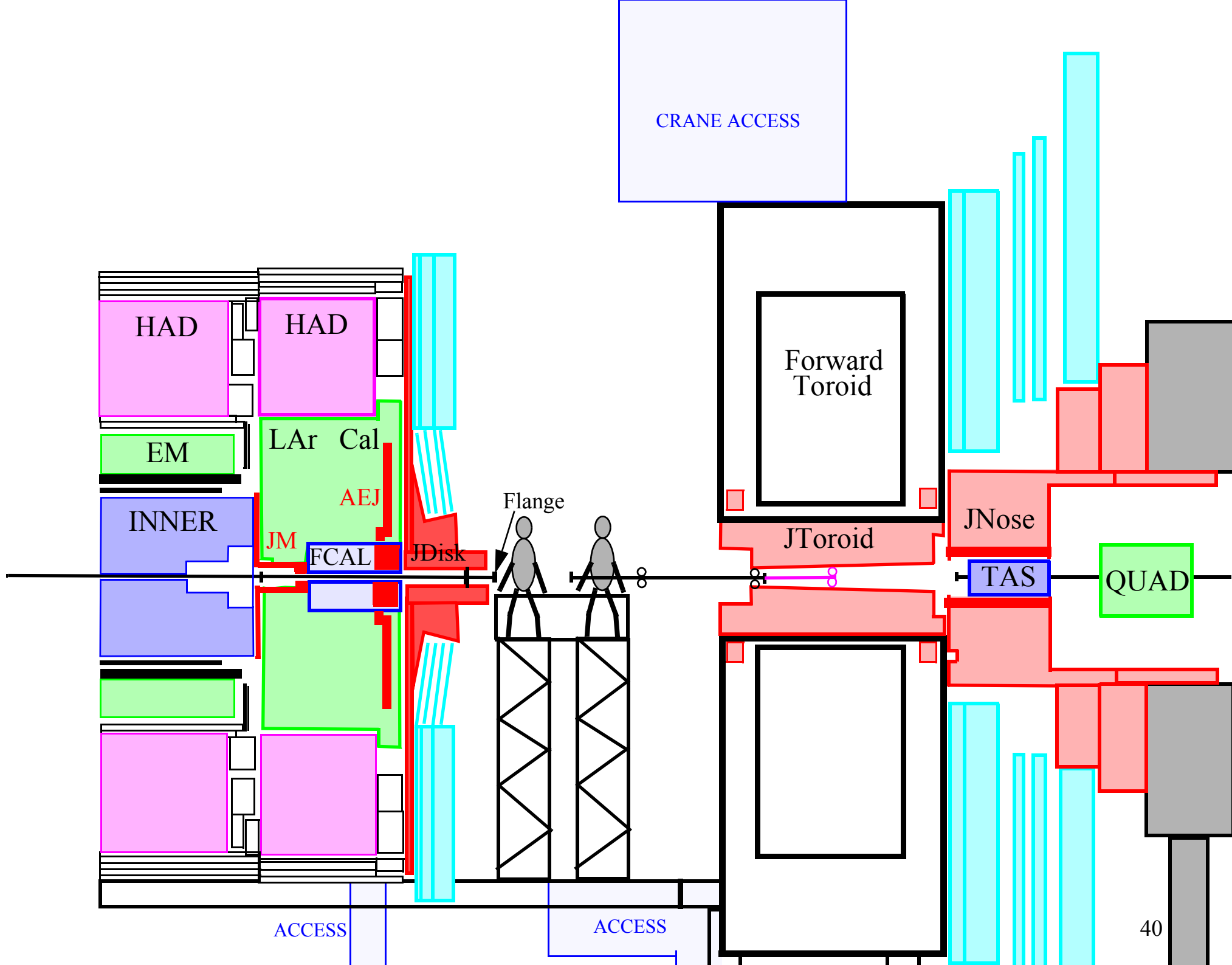

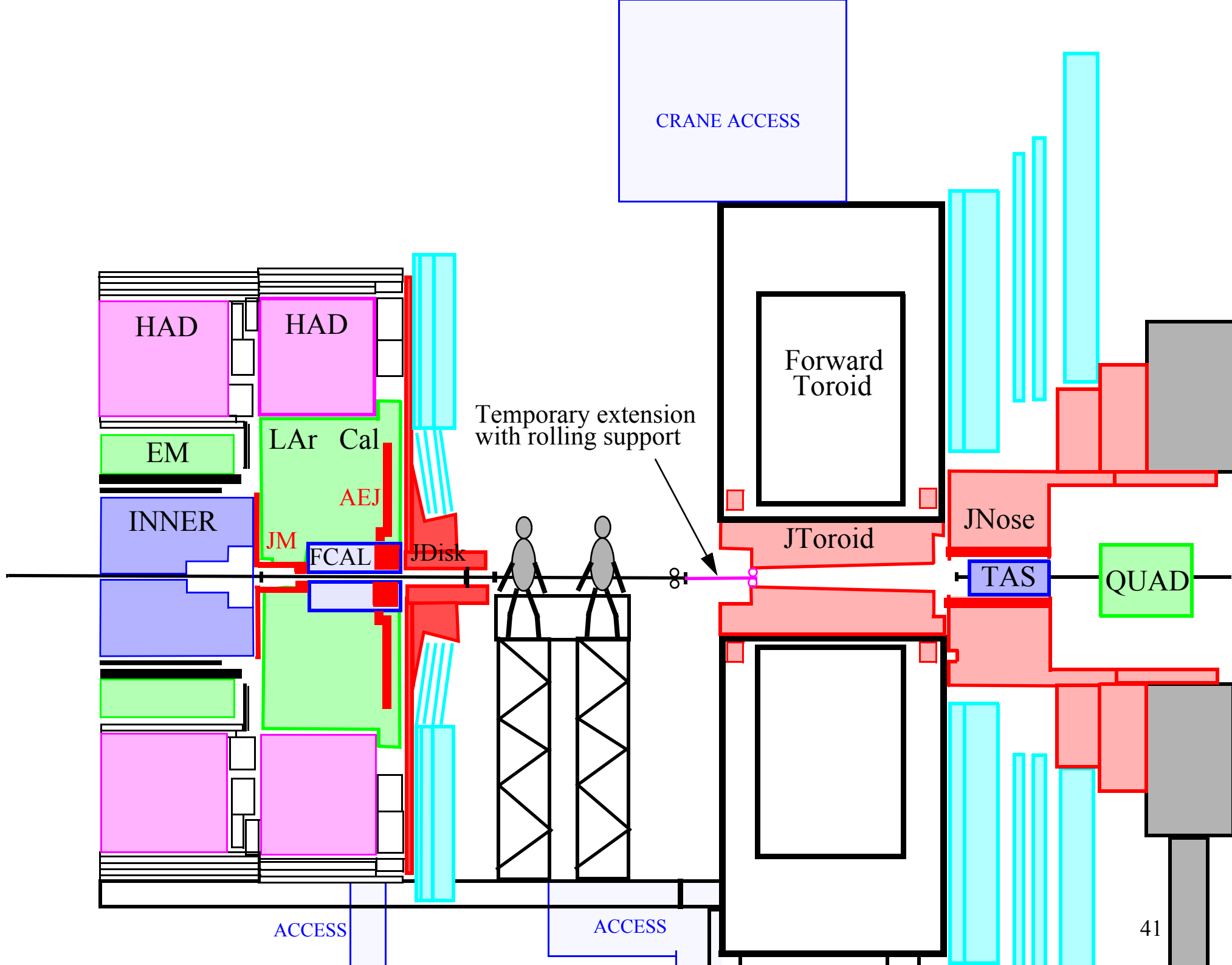

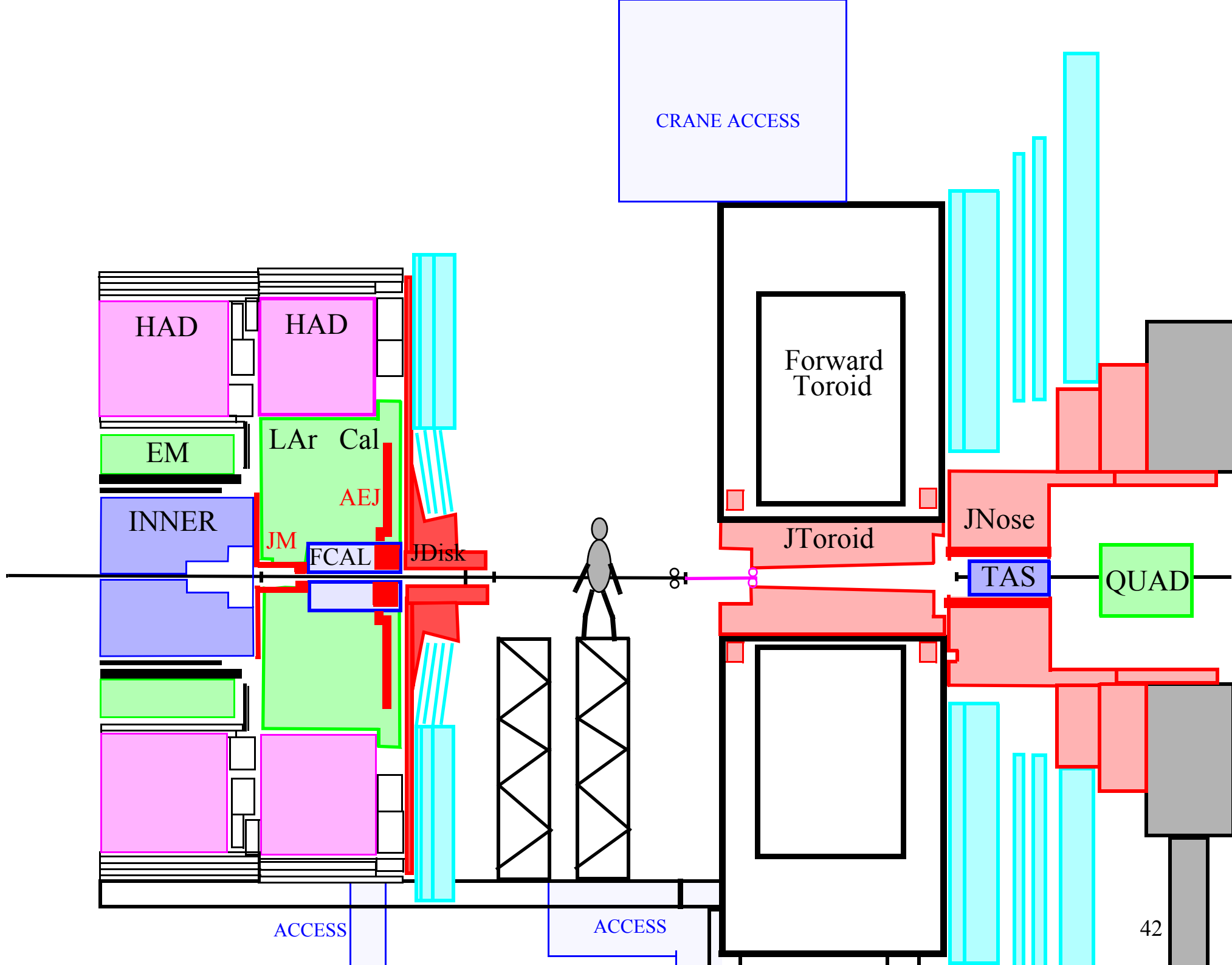

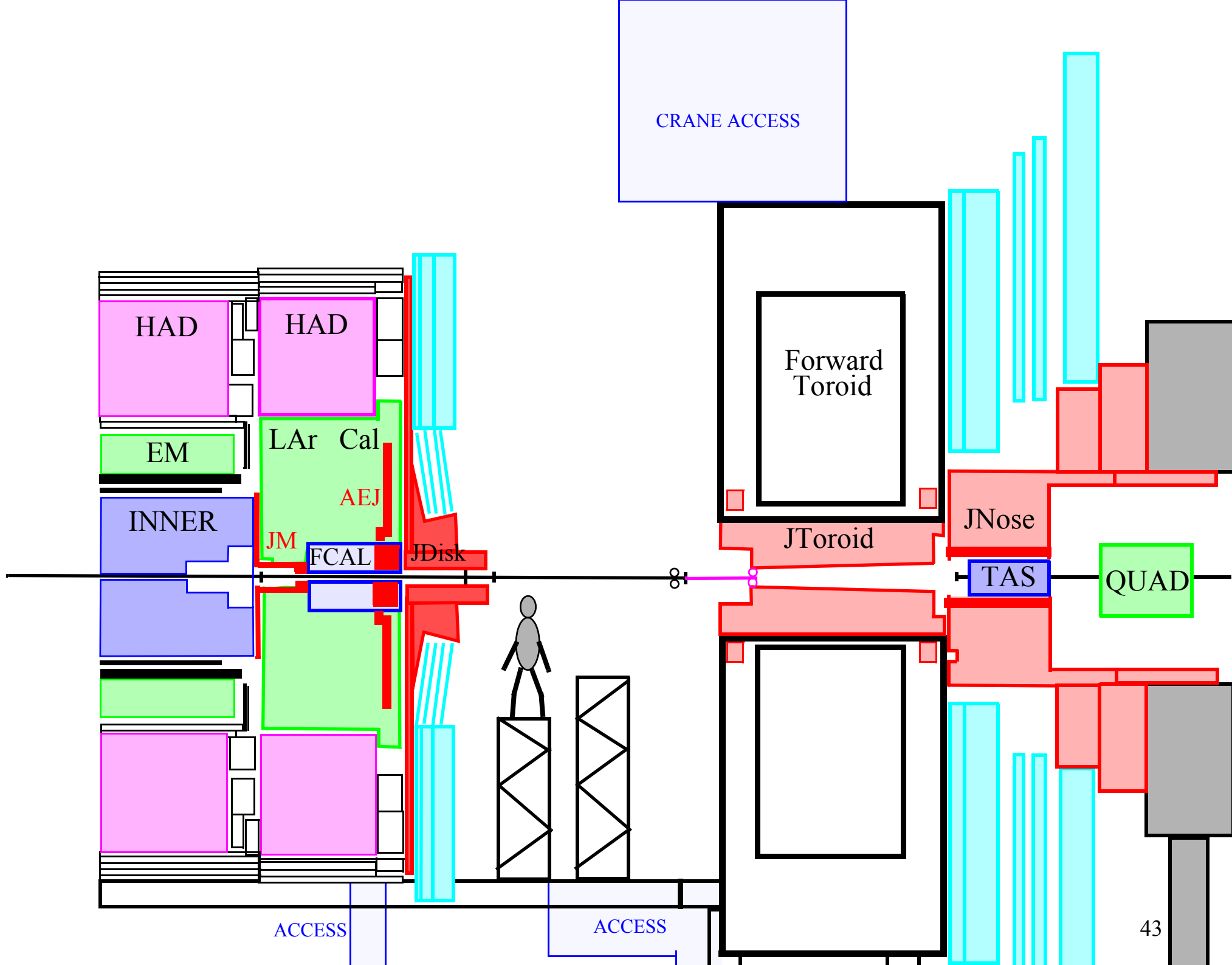

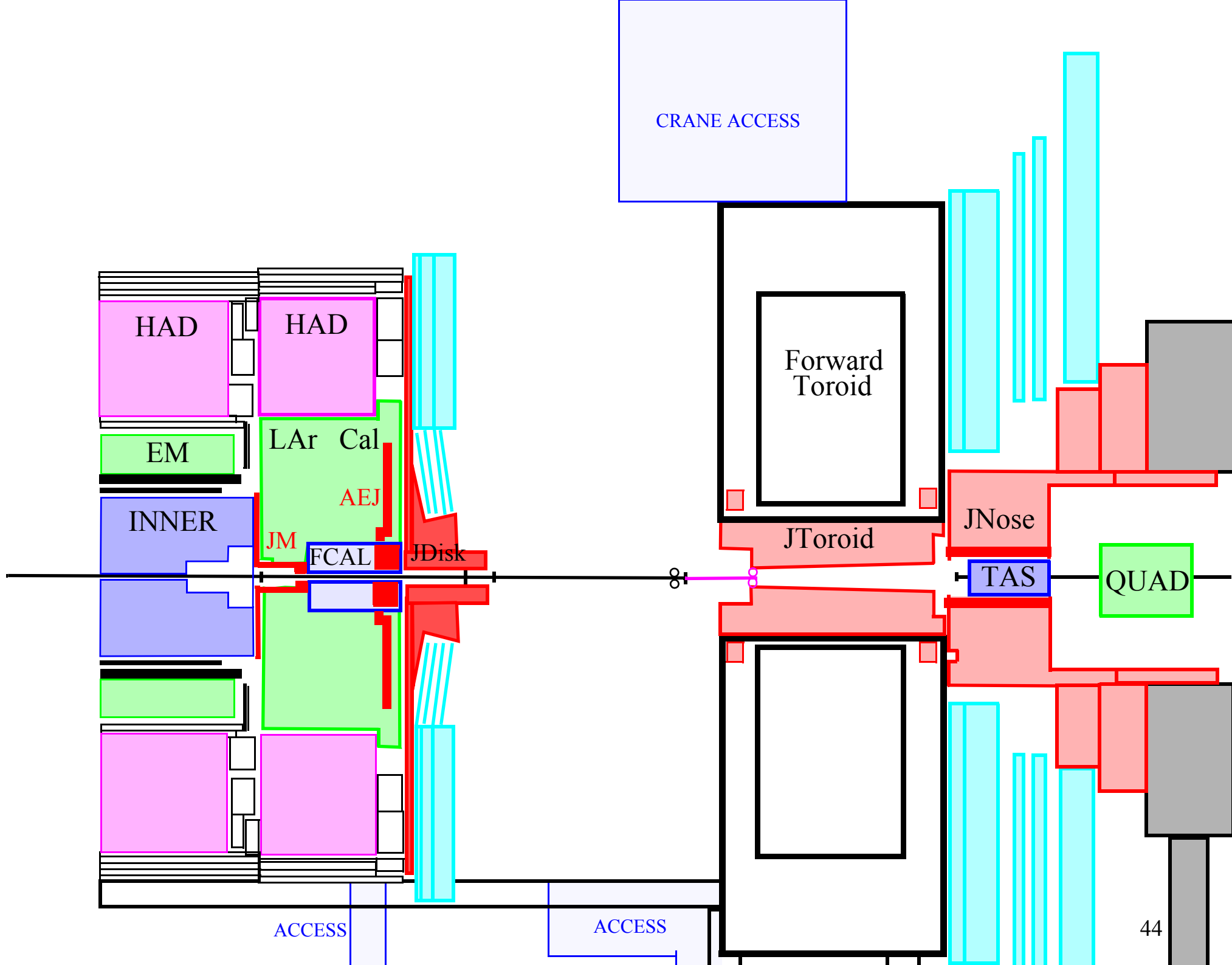

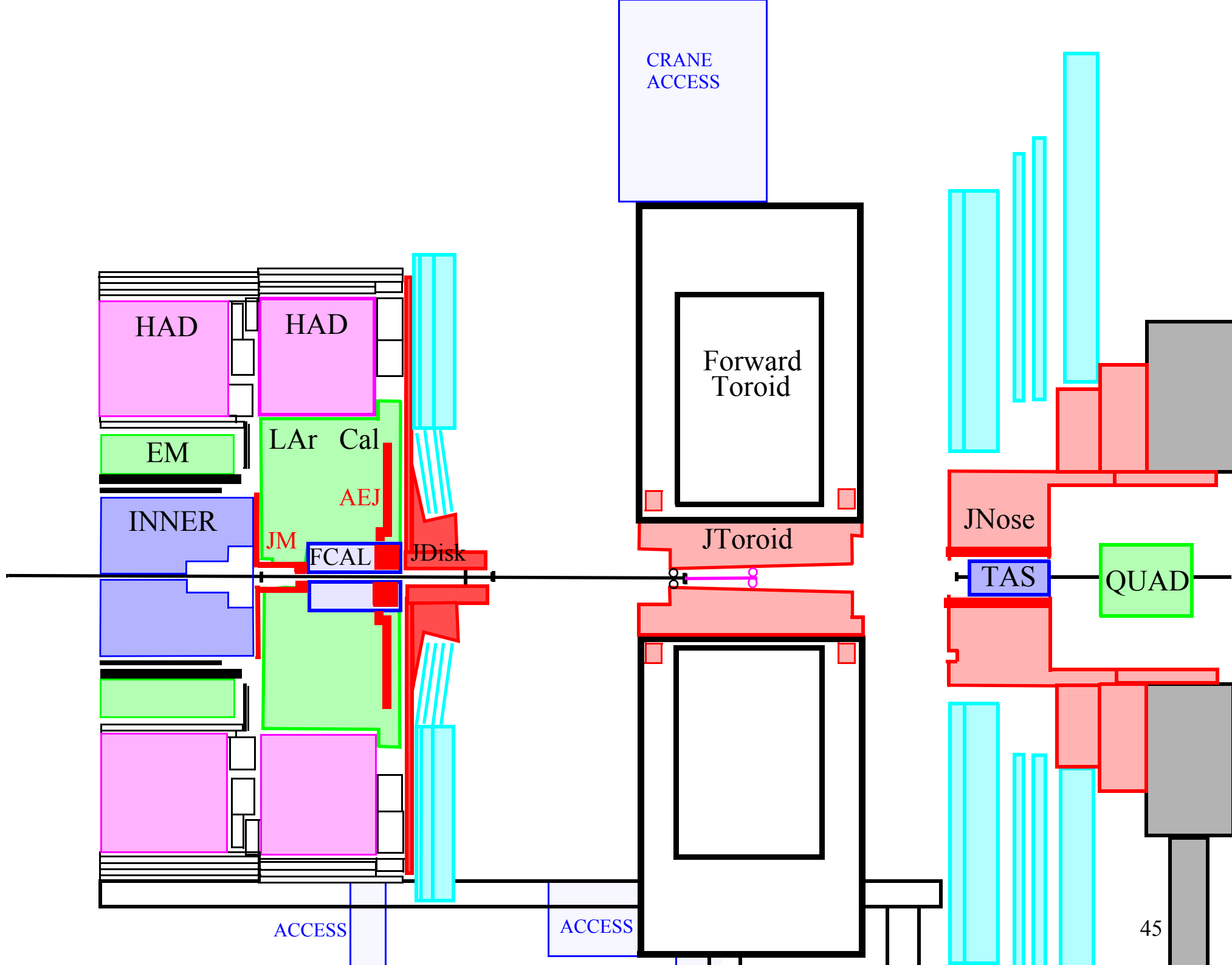

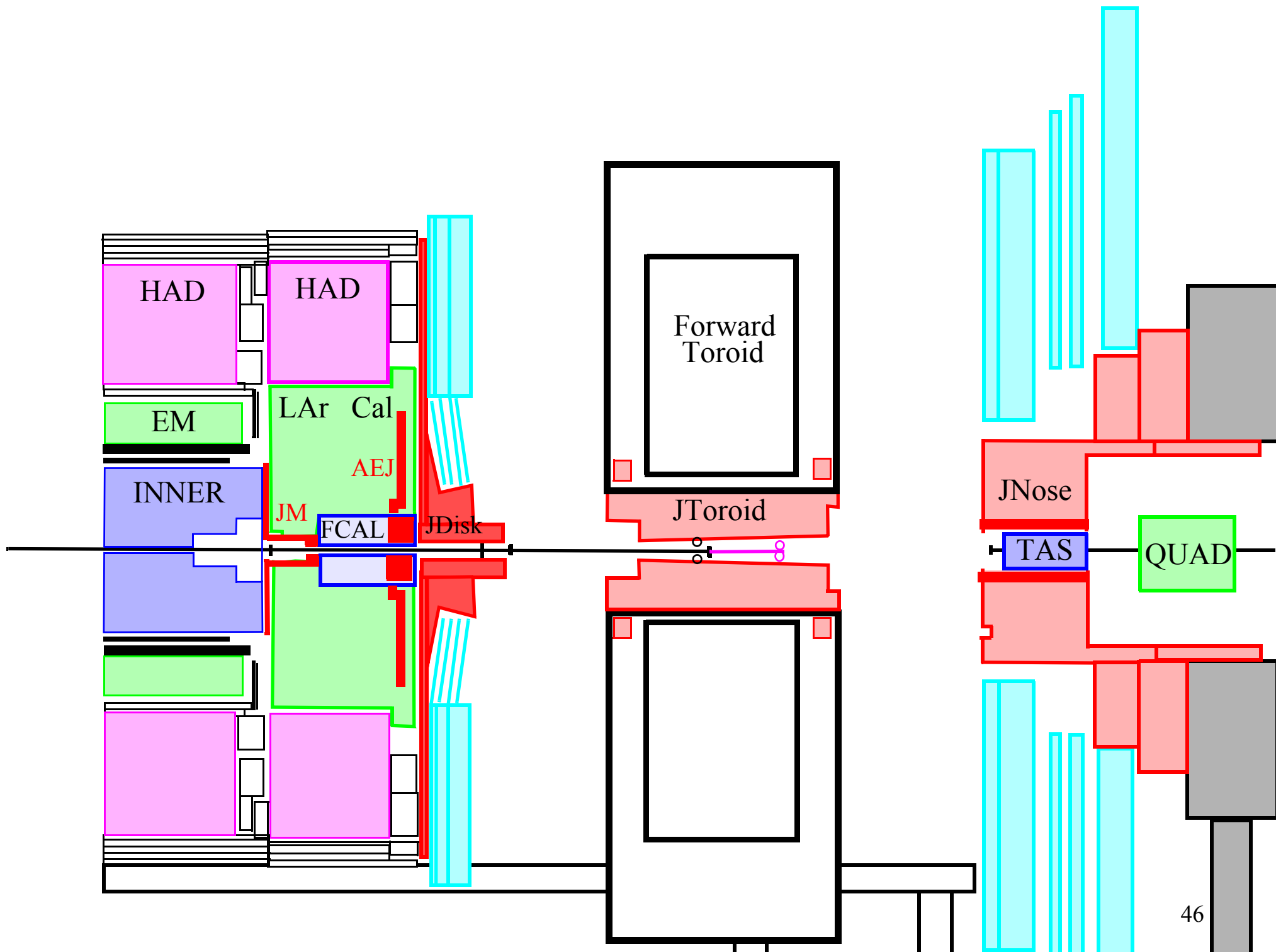

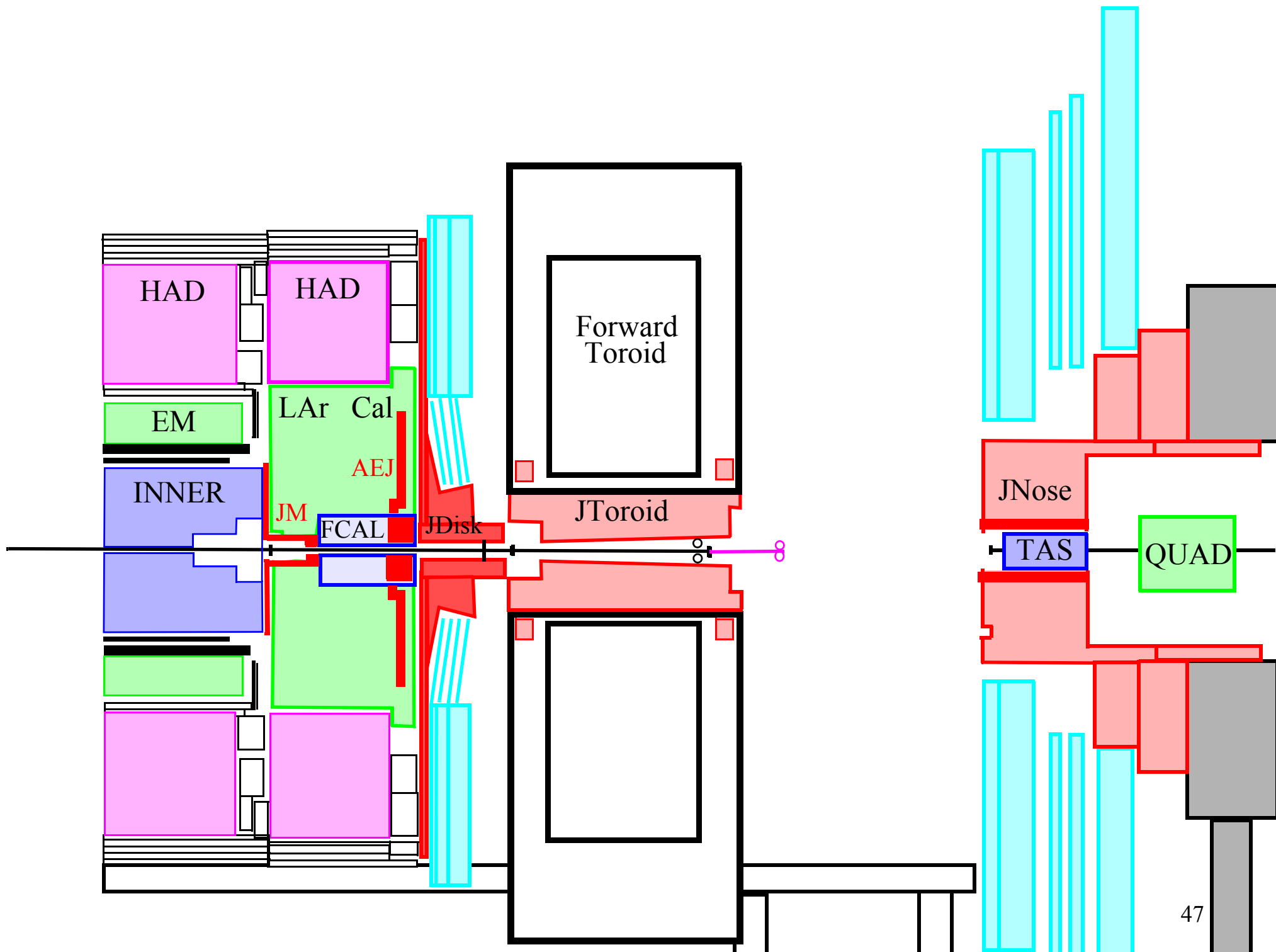

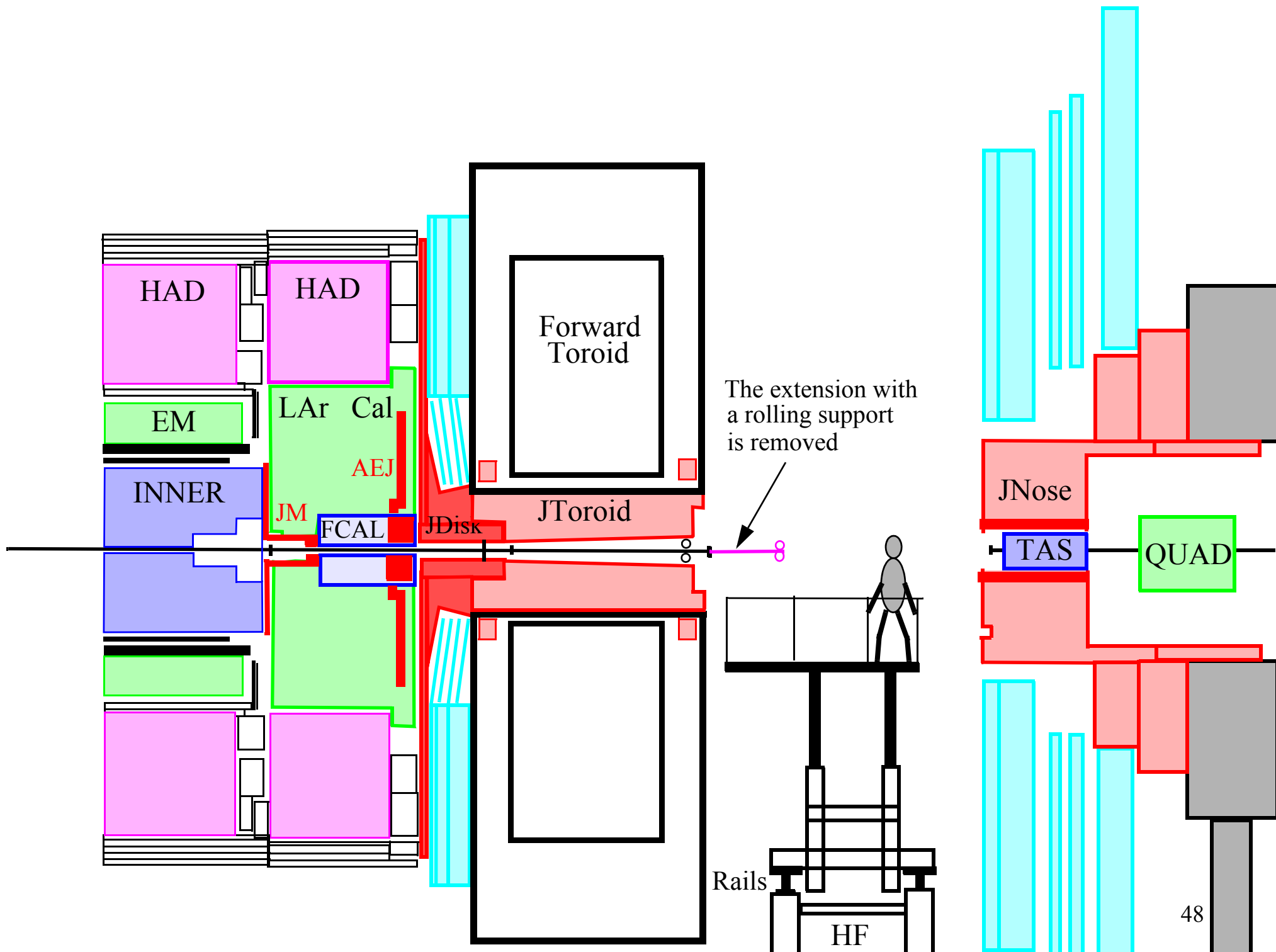

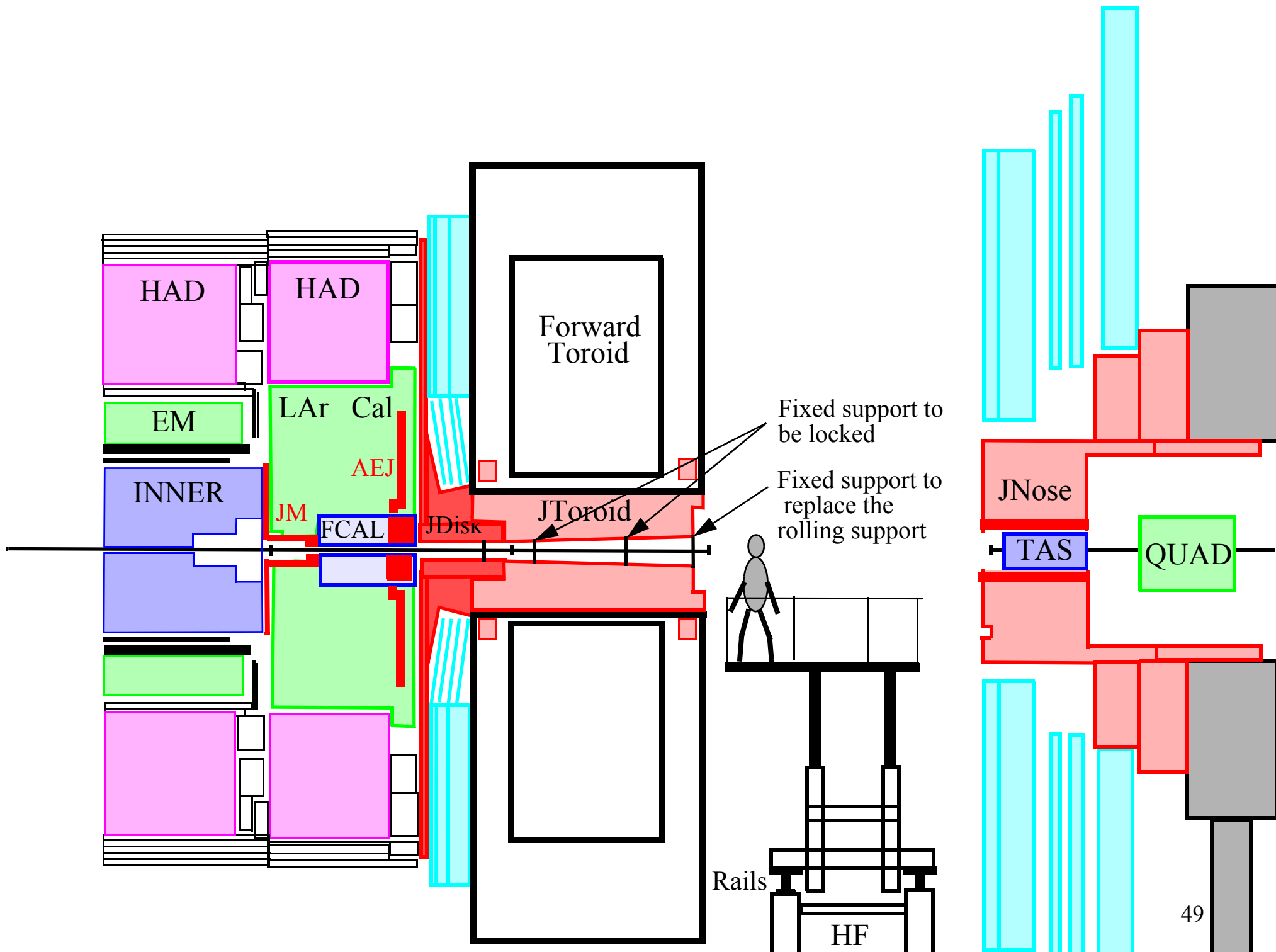

Beampipe supports

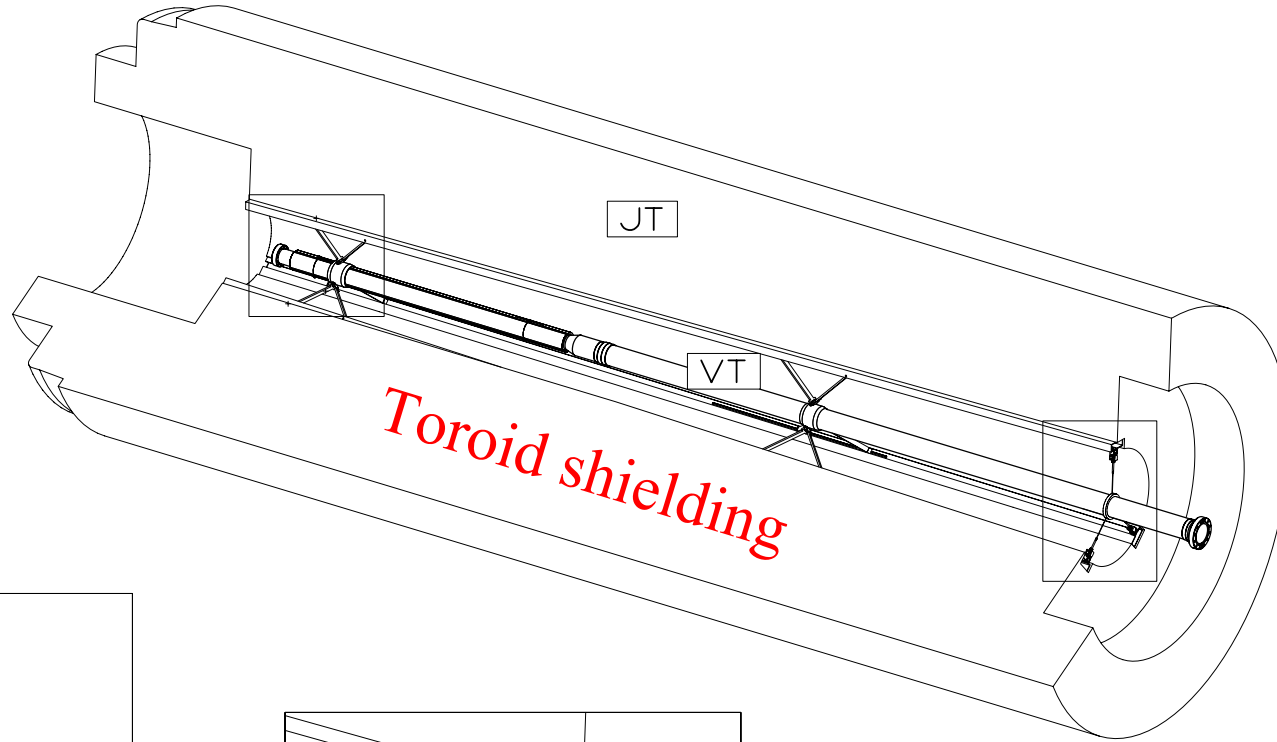

This support has to be locked.

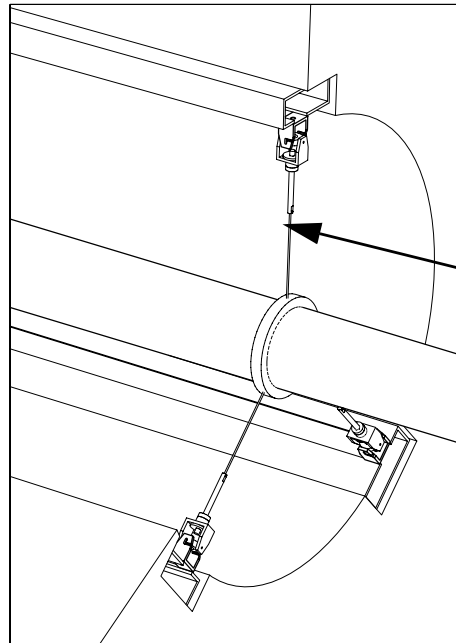
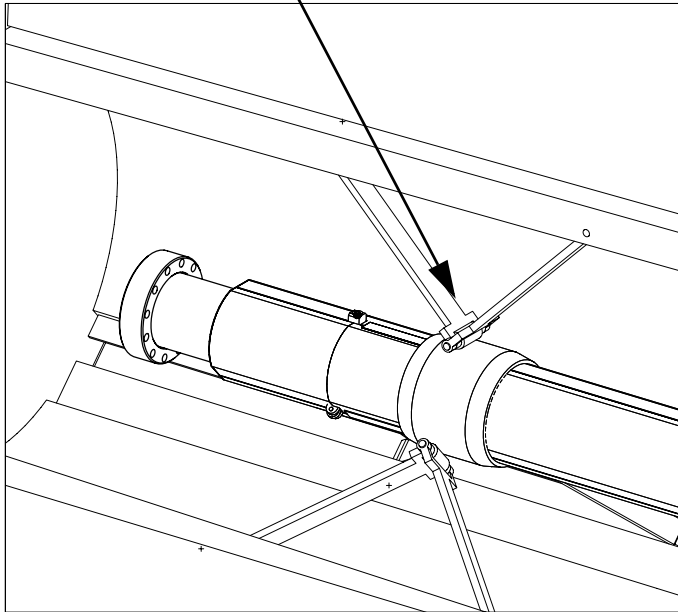
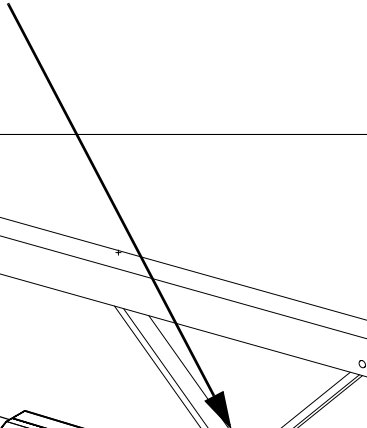

This support has to be attached and the rolling support has to be removed.

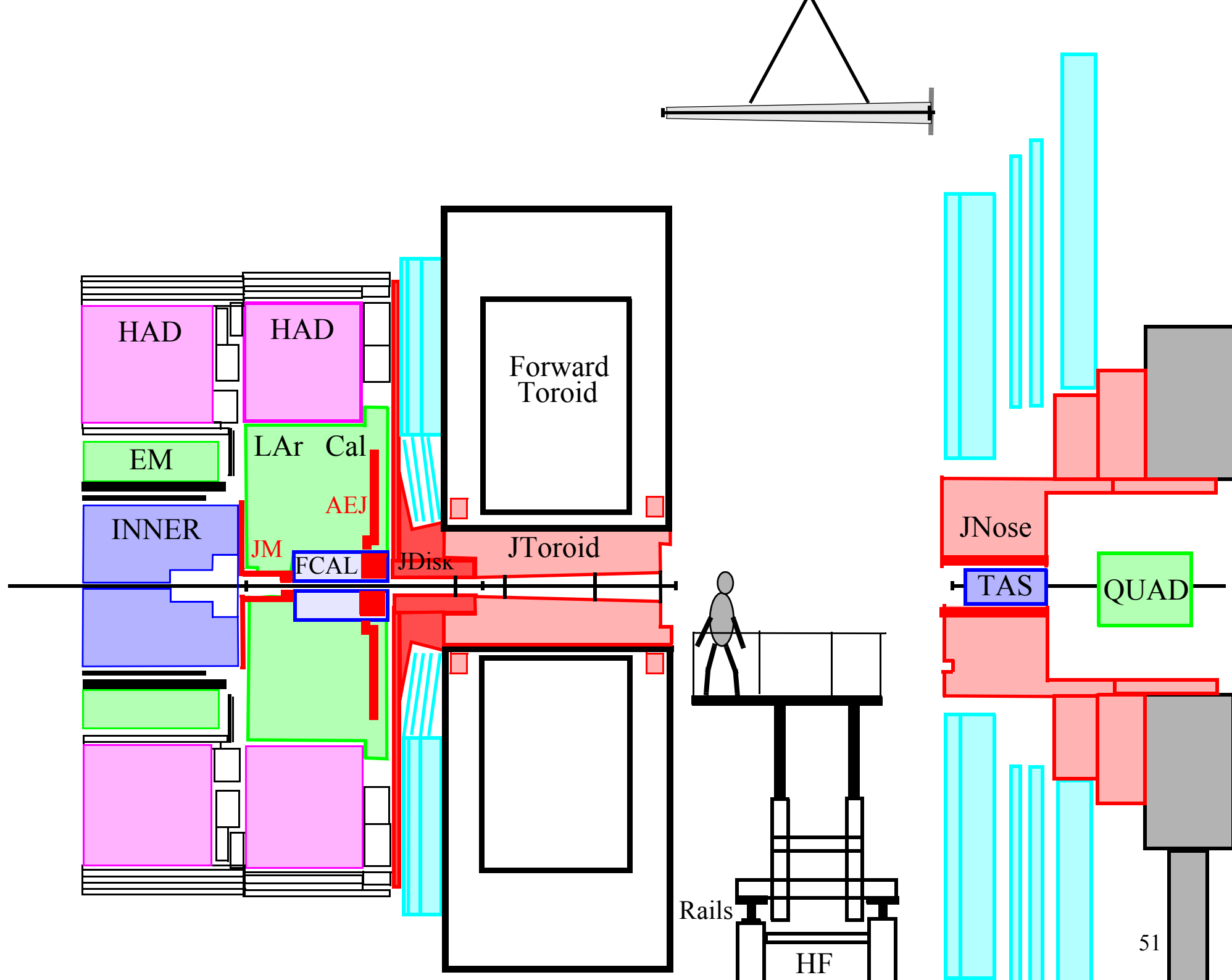

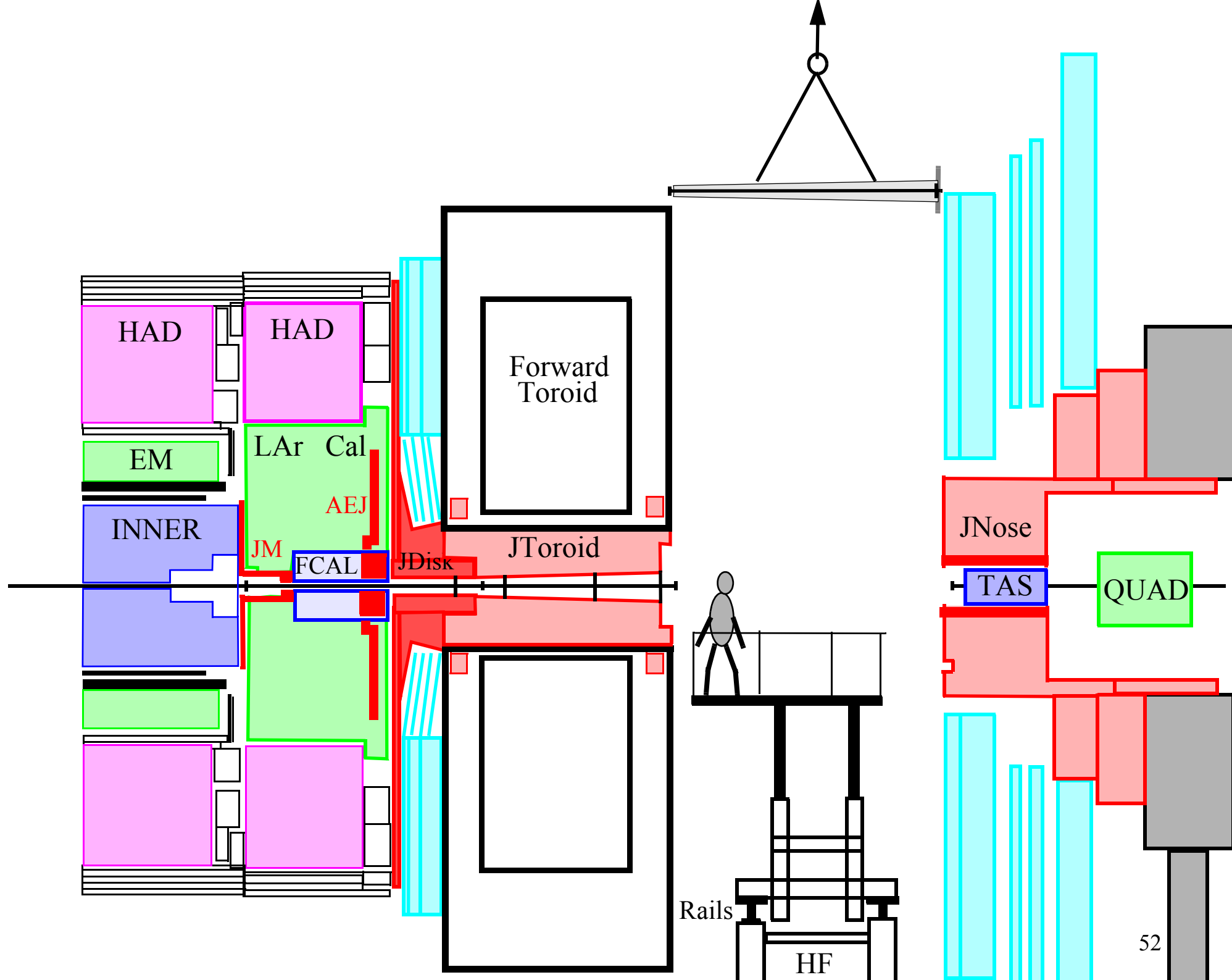

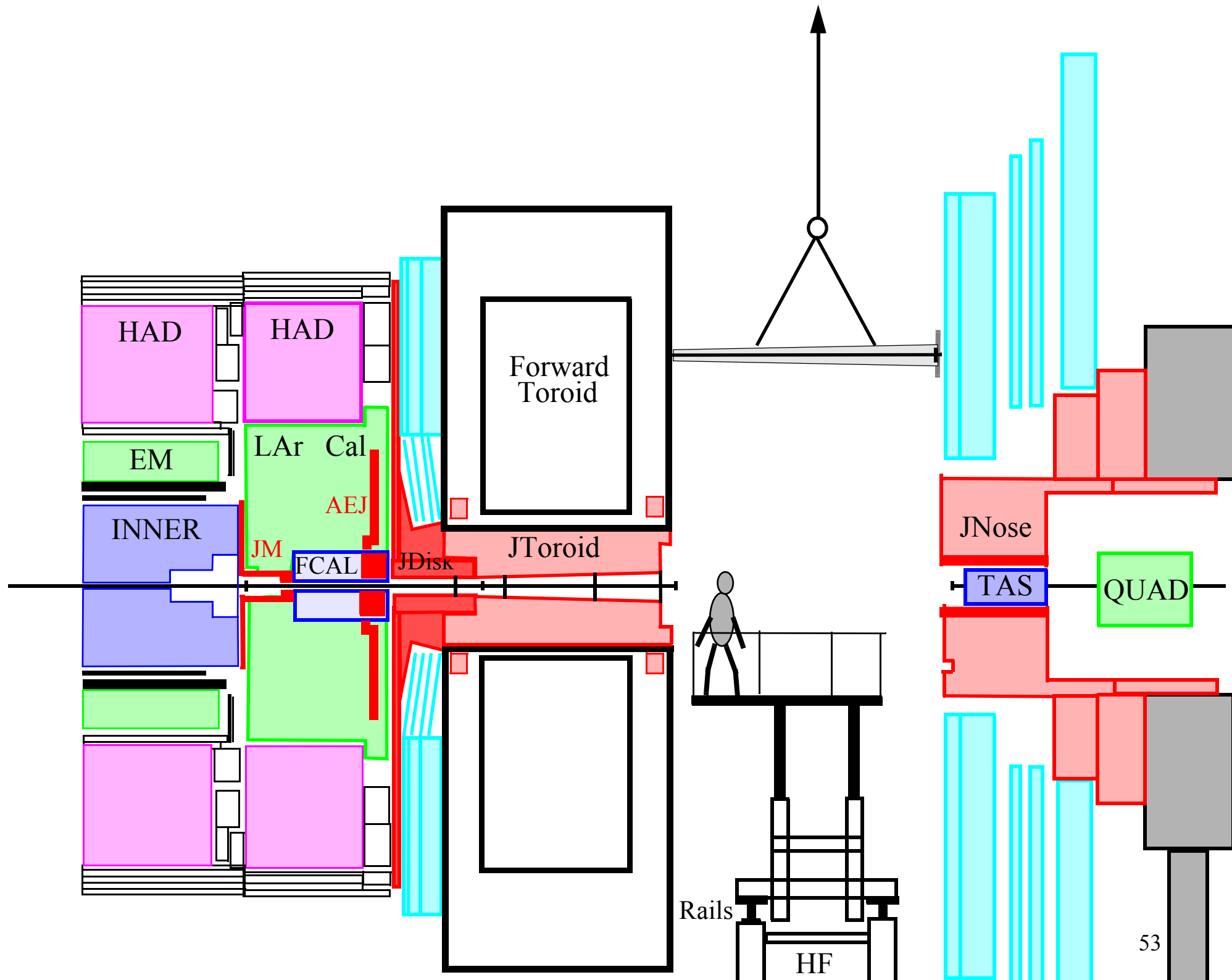

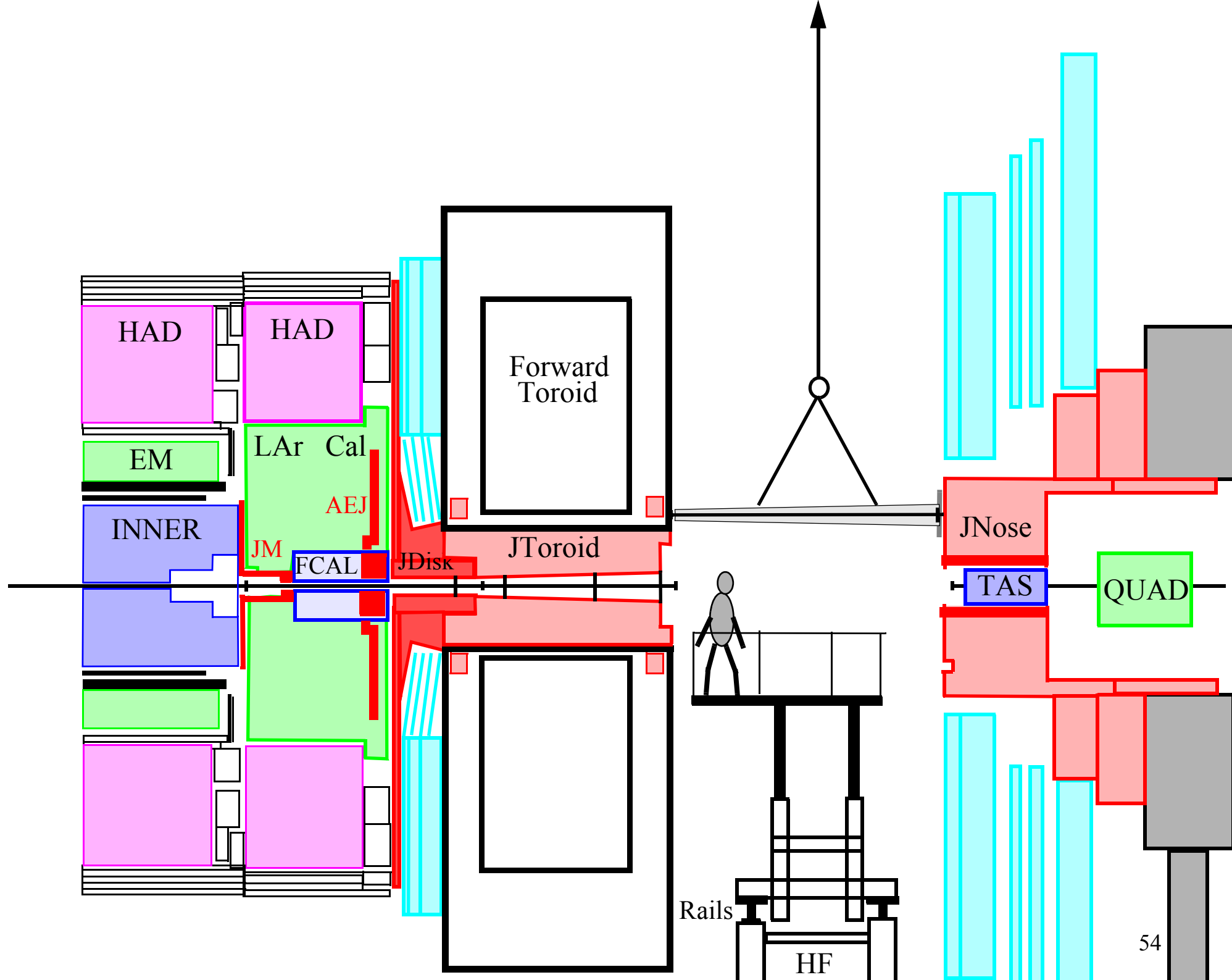

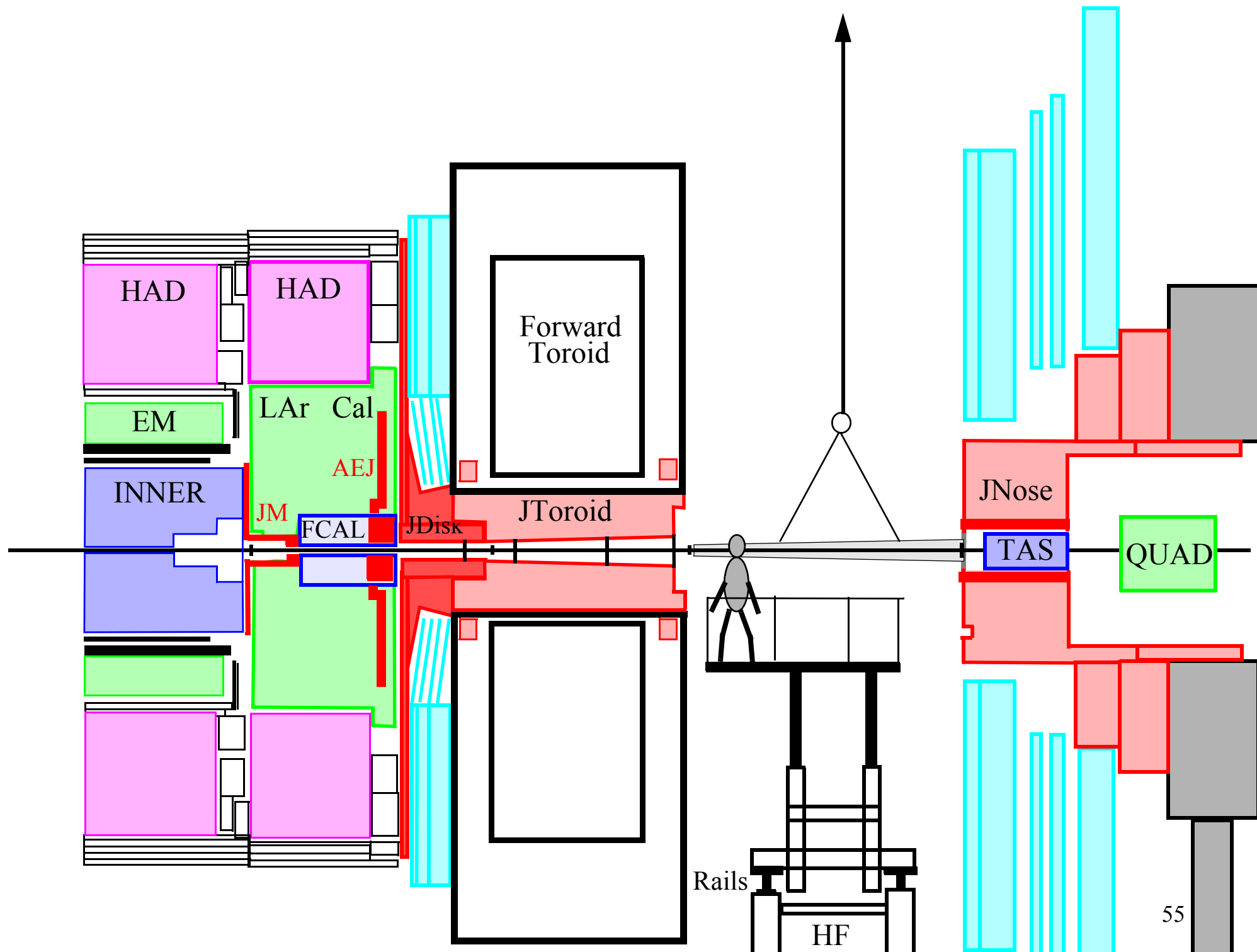

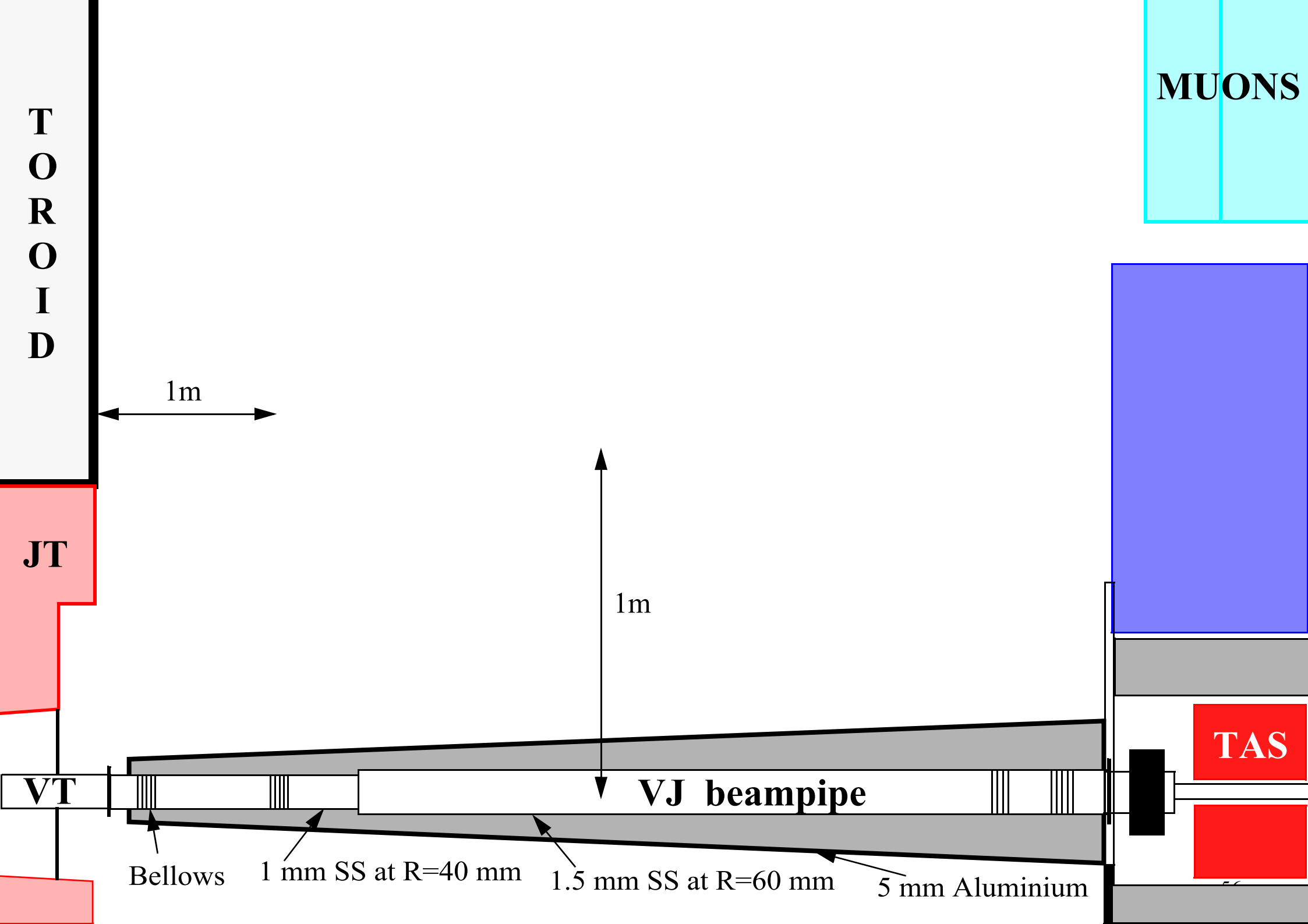

**T
O
R
O
I
D**

MUONS

1m

JT

1m

VT

VJ beampipe

TAS

Bellows

1 mm SS at R=40 mm

1.5 mm SS at R=60 mm

5 mm Aluminium

TAS